

Materialnumber old / new
1739911309 / 5600011178

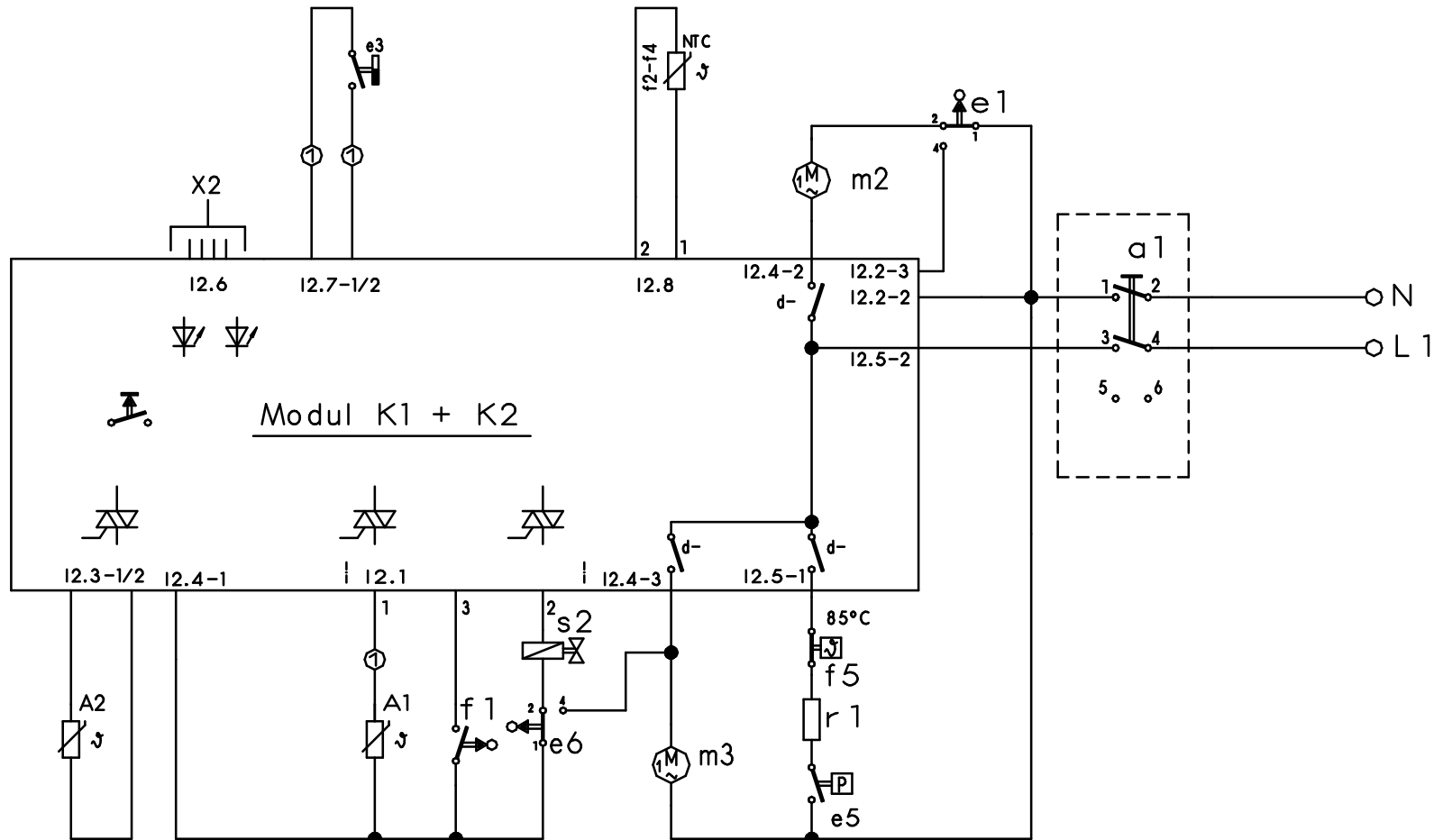

- | | | | |
|-----|----------------------|----|-----------------------|
| a1 | = main switch | m2 | = circulation motor |
| e1 | = door switch | m3 | = drain motor |
| e3 | = door switch | r1 | = heating element |
| e6 | = float switch | e5 | = pressure switch |
| f1 | = level switch | s2 | = filling valve |
| NTC | = temperature sensor | A1 | = actuator upper rack |
| f5 | = thermostat | A2 | = actuator |
| K1 | = display modul | x2 | = service-connector |
| K2 | = control modul | | |

① exit according to equipment



Mat.Nr 1 739 911 309	
Ausg.: 03.98	S0-60/0430

Materialnumber
 old 1739911310
 new 5600011181

control unit

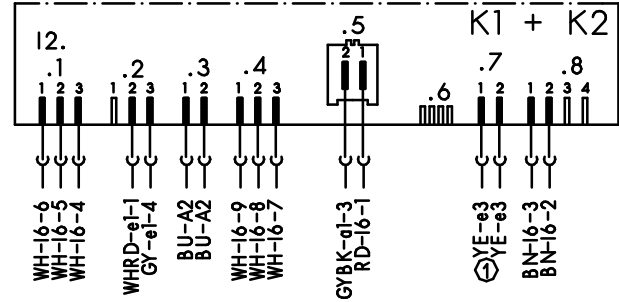

main switch

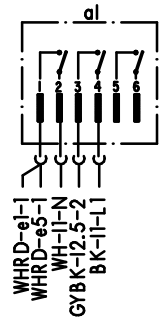

level switch

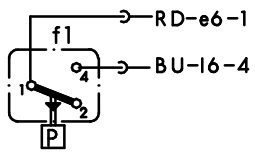

thermostat + NTC

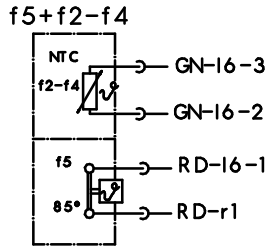

reed switch

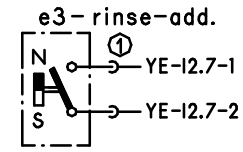

door switch

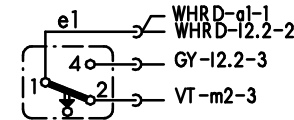

earth terminal

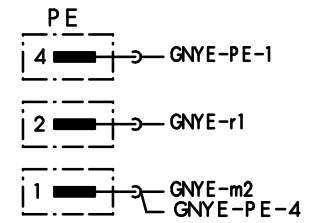

solenoid valves

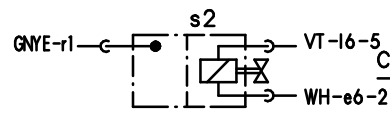

capacitor motor

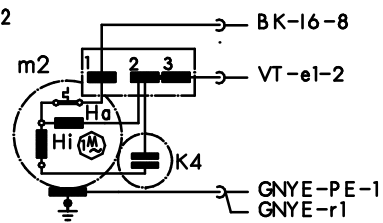

aktuator

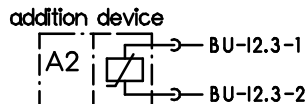

clutch

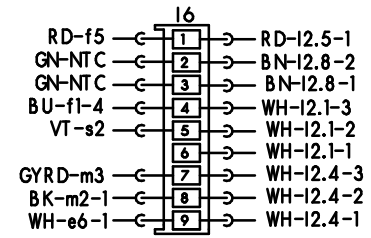

float switch

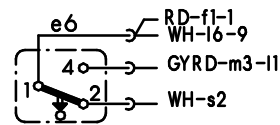

electrical supply I1

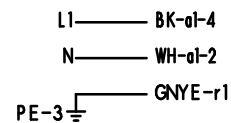

heating

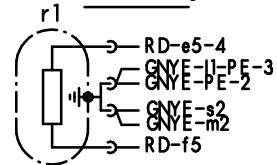

safety switch

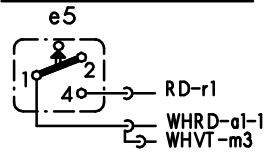

drain pump

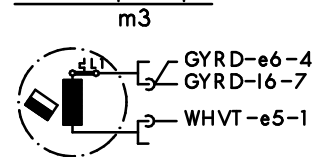

① exist according to equipment



Mat.Nr. 1 739 911 310	
Ausg.: 03.98	S0-60/0431