

LEGEND

- - - COMPONENT MAY OR MAY NOT BE USED
- TIMER CONSTRUCTION
- TERMINAL CONNECTION
- SPLICE
- ∞ IN LINE CONNECTION

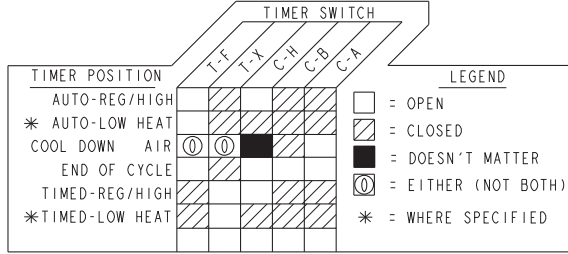

- LEGEND
- = OPEN
 - ▨ = CLOSED
 - = DOESN'T MATTER
 - ⊙ = EITHER (NOT BOTH)
 - * = WHERE SPECIFIED

MANUFACTURED UNDER ONE OR MORE OF THE FOLLOWING US PATENTS:
 4669200, 4700495, 4754556, 4840285, 4865366, 4899464,
 4908959, 4989347, 5066050, 5560120, 5809828, 6020698,
 6047486, 6199300, 6446357, D314261, D314262, D457991,
 D457992

CAUTION: LABEL ALL WIRES PRIOR TO DISCONNECTION WHEN SERVICING CONTROLS. WIRING ERRORS CAN CAUSE IMPROPER AND DANGEROUS OPERATION. VERIFY PROPER OPERATION AFTER SERVICING.

WARNING - DISCONNECT FROM ELECTRICAL SUPPLY BEFORE SERVICING UNIT

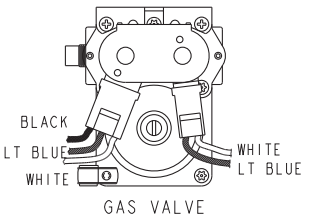
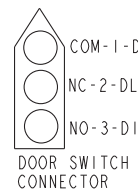
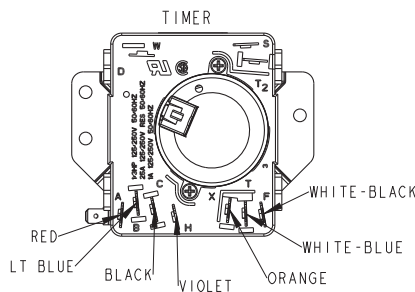
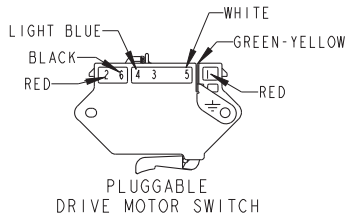
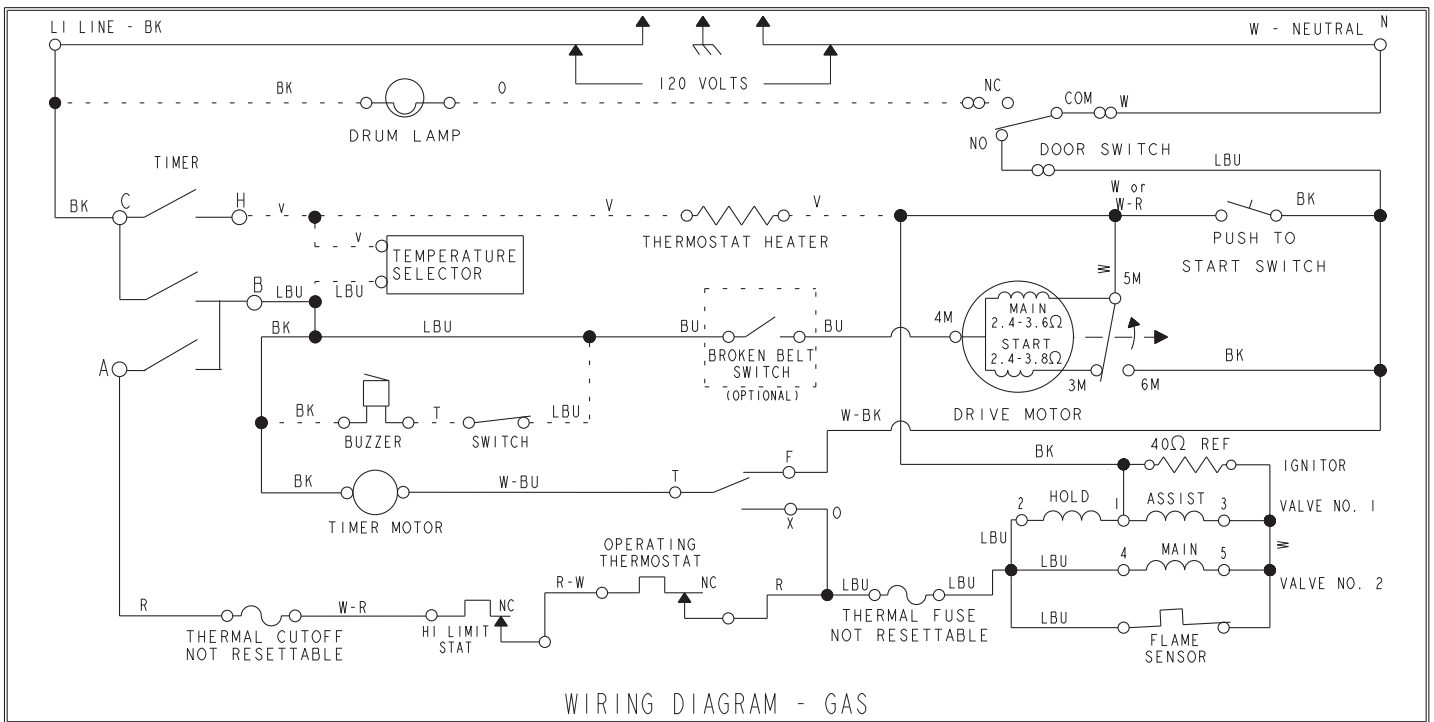
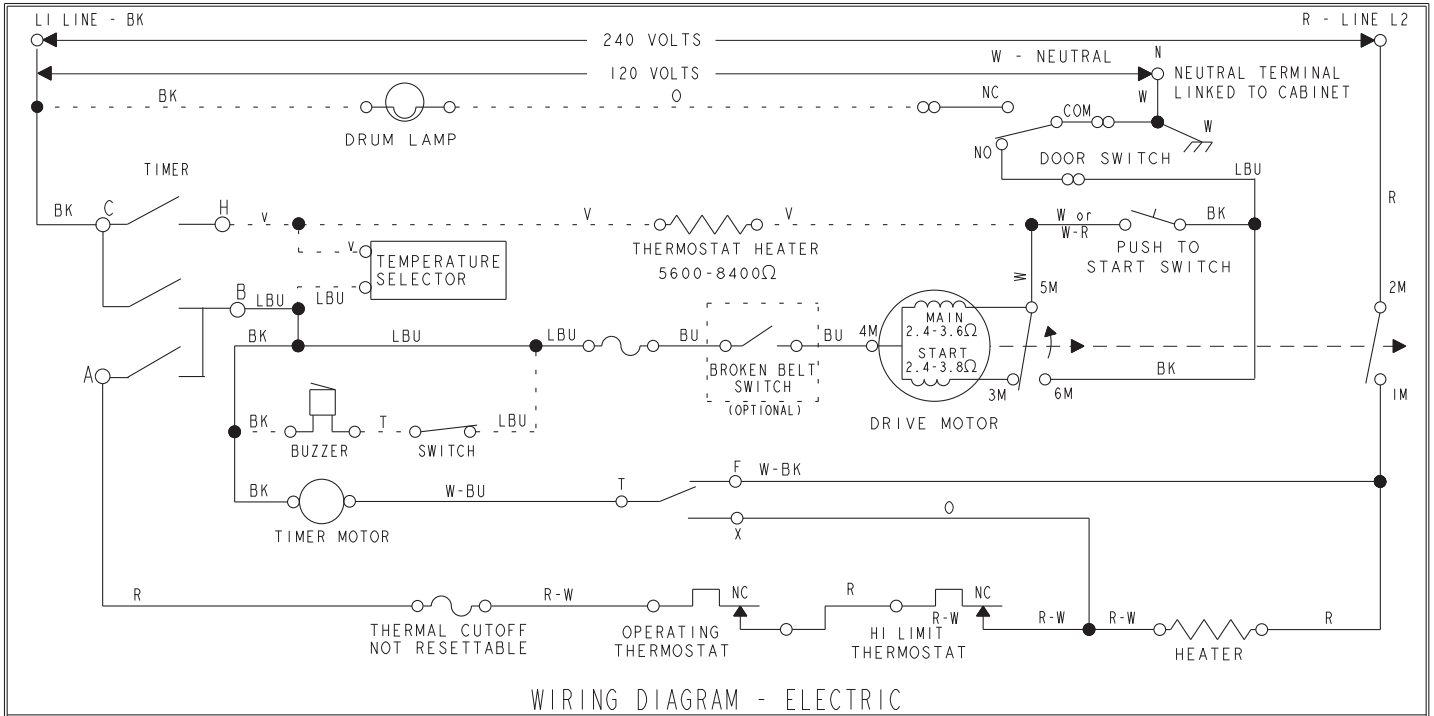

LABEL NO.
W10185979
 REV. H