

GE Appliances

# Technical Service Guide

August 2011

## Profile Bottom Mount Ice and Water Refrigerators

PGCS1RKZ

PFCF1RKZ

PFSS5RKZ

PGSS5RKZ

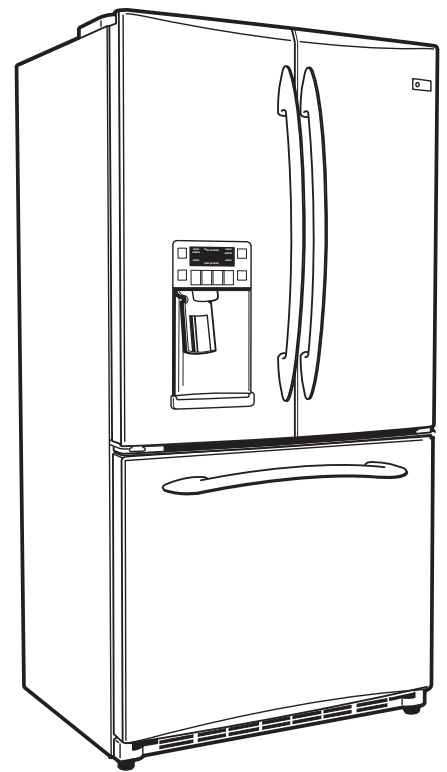
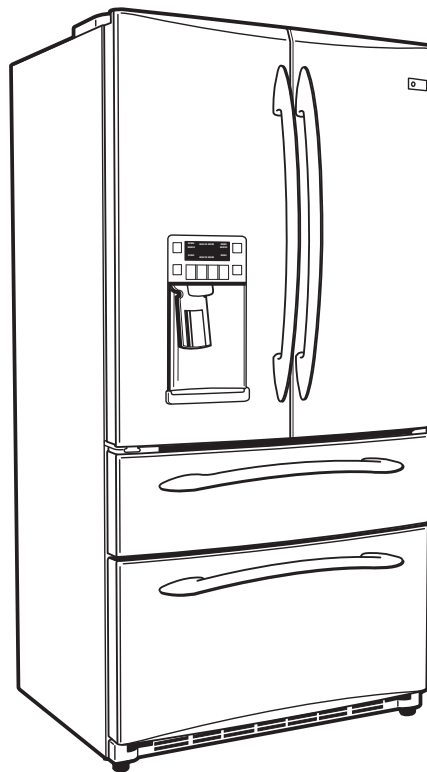

31-9215



GE Appliances  
General Electric Company  
Louisville, Kentucky 40225



### **IMPORTANT SAFETY NOTICE**

The information in this service guide is intended for use by individuals possessing adequate backgrounds of electrical, electronic, and mechanical experience. Any attempt to repair a major appliance may result in personal injury and property damage. The manufacturer or seller cannot be responsible for the interpretation of this information, nor can it assume any liability in connection with its use.

### **WARNING**

To avoid personal injury, disconnect power before servicing this product. If electrical power is required for diagnosis or test purposes, disconnect the power immediately after performing the necessary checks.

### **RECONNECT ALL GROUNDING DEVICES**

If grounding wires, screws, straps, clips, nuts, or washers used to complete a path to ground are removed for service, they must be returned to their original position and properly fastened.

*GE Appliances*  
*Technical Service Guide*  
*Copyright © 2011*

All rights reserved. This service guide may not be reproduced in whole or in part in any form without written permission from the General Electric Company.

# Table of Contents

Airflow .....	20
Anti-Tip Floor Bracket (on 21-ft. models) .....	7
Articulating Door Mullion .....	52
Auger Motor.....	35
Bottom Freezer Drawer.....	27
Components.....	22
Components Locator Views.....	17
Condenser Fan.....	56
Control Board Connector Locator.....	15
Control Diagnostics Using Temperature Display.....	60
Control Features.....	9
Defrost Heater.....	45
Deli Pan Removal.....	14
Dispenser and Interface.....	36
Door and Drawer Gaskets.....	29
Door Closure Mechanisms.....	22
Double Drawer Mullion Assembly.....	53
EMI Filter.....	54
Evacuation and Charging Procedure.....	48
Evaporator.....	41
Evaporator Fan.....	43
Freezer Drawer/Fresh Food Door Handles.....	22
Fresh Food and Freezer Lights.....	38
Fresh Food Damper.....	49
Fresh Food Door Removal.....	24
Fresh Food/Freezer Mullion Heater.....	54
Heater Troubleshooting.....	63
Humidity Sensor.....	50
Ice Bucket.....	34
Ice Compartment.....	30
Ice Compartment Fan.....	44
Icemaker.....	33
Icemaker Service Test Mode.....	64
Installation.....	7
Introduction.....	4
Inverter.....	57
Inverter Compressor.....	59
Mullion Heaters.....	51
Nomenclature.....	6
Over-Temperature Thermostat.....	46
Refrigeration Components.....	19
Refrigeration System.....	19
Replacing Evaporator Using Brazing Method.....	47
Replacing Evaporator Using LOKRING Method.....	47
Return Duct Heaters.....	46
Schematic.....	65
Technical Data.....	5
Thermistors.....	40
Top Freezer Drawer.....	26
Troubleshooting.....	60
Warranty.....	66
Water Valve.....	55

# Introduction

This new Profile Bottom Mount Ice and Water Refrigerator has the following features:\*

- Available in 21- and 25-cubic foot capacity, single freezer or double drawer freezer model with fresh food french door configuration.
- ENERGY STAR® qualified.
- In-the-door icemaker produces filtered cubed or crushed ice from the door of the refrigerator, without taking up food-storage space in the fresh-food section.
- Tall dispenser allows filtered water and ice to fill large pitchers or bottles from inside the door without taking up fresh food space,
- Two coil water tanks provide added storage volume with increased surface area for quick temperature recovery.
- ClimateKeeper™ Temperature Management System, digital controls, and electronic sensors give you a greater degree of control over food preservation. An external "air" thermistor changes the control setting based on ambient condition to keep the fresh food and freezer at the correct temperature.
- TurboCool™ — Rapidly cools the refrigerator compartment in order to more quickly cool foods.
- An articulating door mullion, attached to the left-side door, provides a movable center mullion that maximizes access to the fresh food compartment.
- Damper/air inlet assembly, located in the bottom of the fresh food section, creates more usable space on the top shelf.
- Secure-Close Door Systems - Securely pulls the doors and drawers shut, even after you release the handles.
- Anti-tip kit will be required for 21 cubic foot models.
- Ramp-up LED Lighting - Crisp, white lighting increases as the doors are opened until full illumination.
- The 3-speed compressor is controlled by an inverter that receives input from the low voltage DC-side of the main control board. The inverter always has 120 VAC applied when the refrigerator is connected to power. The main control board still makes compressor decisions based on the input of thermistors, door-open time, and input from the LCD display. The main control also operates all other electrical components in the refrigerator such as the water valve, fan motors, lights, etc.



\* Features may vary by model.

# Technical Data

## DISCONNECT POWER CORD BEFORE SERVICING

### IMPORTANT - RECONNECT ALL GROUNDING DEVICES

All parts of this appliance capable of conducting electrical current are grounded. If grounding wires, screws, straps, clips, nuts or washers used to complete a path to ground are removed for service, they must be returned to their original position and properly fastened.

## IMPORTANT SAFETY NOTICE

This information is intended for use by individuals possessing adequate backgrounds of electrical, electronic and mechanical experience. Any attempt to repair a major appliance may result in personal injury and property damage. The manufacturer or seller cannot be responsible for the interpretation of this information, nor can it assume any liability in connection with its use.

## ELECTRICAL SPECIFICATIONS

Temperature Control (Position 5).....	7-(-11)°F
Defrost Control (w/no door openings).....	96hrs @ 45 min
Thermistor kilo-ohm resistance.....	@0°F..... 42.5
.....	@37°F..... 14
.....	@77°F..... 5
Overtemperature Thermostat.....	140-110°F
Defrost Thermistor.....	50°F
Electrical Rating: 115V AC 60 Hz.....	11.6 Amp
Maximum Current Leakage.....	0.75 mA
Maximum Ground Path Resistance.....	0.14 Ohms

## NO LOAD PERFORMANCE

Control Position 5/5 and Ambient of 65°F to 90°F

Fresh Food, °F.....	34 to 40
Frozen Food, °F.....	-3 to 3F
Run Time, % @ 65°F.....	30 to 50
Run Time, % @ 90°F.....	50 to 80

## REFRIGERATION SYSTEM

Compressor 21, 25 Models.....	833 BTU/hr @ 3000 RPM
Minimum Compressor Capacity.....	22 inches Hg
Minimum Equalized Pressure	
@ 70°F.....	45 to 48 PSIG
@ 90°F.....	54 to 60 PSIG

## REFRIGERANT CHARGE (R134a)

21, 25 models.....	5.50 ounces
--------------------	-------------

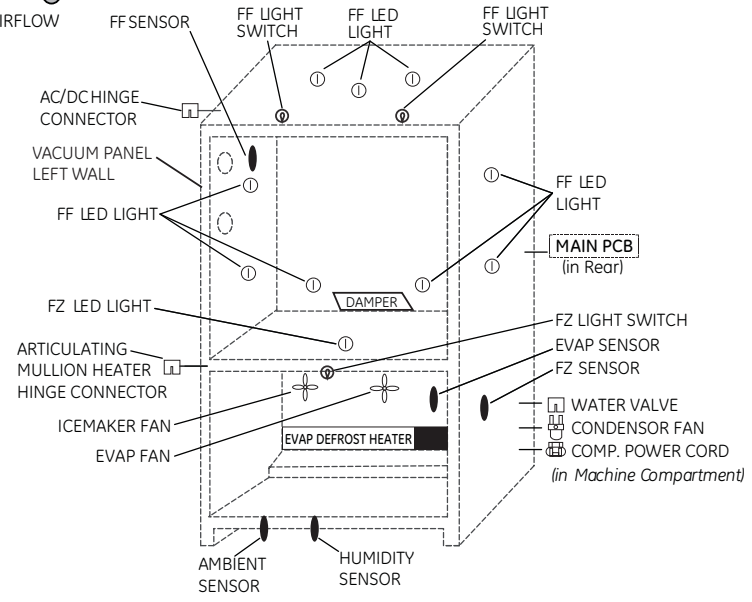
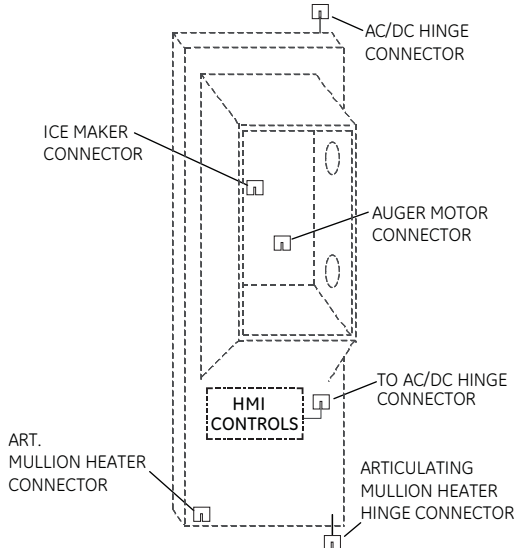
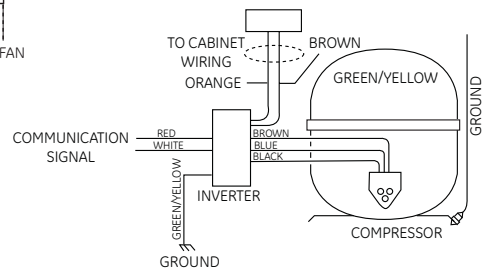
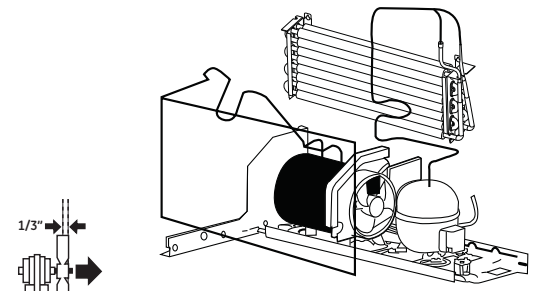
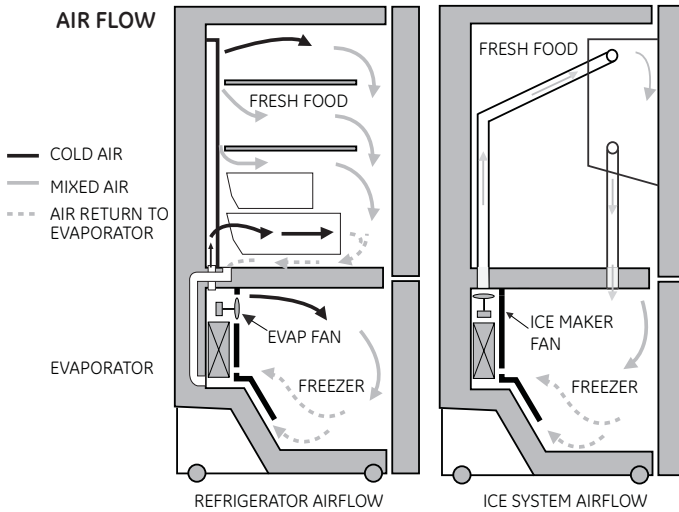

# Nomenclature

**P G C S 1 R K Z A S S**

**Brand/Product**

P - Profile

**Configuration**

F - French Door

G - French Door w/Double FZ Drawer

**Style**

C - Custom Style

S - Standard Depth

**Exterior**

F - High Gloss

S - Stainless Steel

**Capacity**

1 - 21 Cubic Foot

5 - 25 Cubic Foot

**Exterior Color**

BB - Black/Black

SS - Stainless/Stainless

WW - White/White

**Engineering**

A - Initial Design

**Model Year**

Z - 2010

**Ice/Water**

K - External Cubed and Crushed Ice/Water  
1 Year Filter/Icemaker

**Feature Pack**

The nomenclature plate is located on the upper left wall of the fresh food compartment. It contains the following information:



- Model and Serial Number
- Minimum Installation Clearances
- Electrical Voltage, Frequency
- Maximum Amperage Rating
- Refrigerant Charge and Type

Mini-Manual Location

## Serial Number

The first two characters of the serial number identify the month and year of manufacture.

*Example: RV123456S = August, 2011*

R - AUG	2011 - V
S - SEP	2010 - T
T - OCT	2009 - S
V - NOV	2008 - R
Z - DEC	2007 - M
A - JAN	2006 - L
B - FEB	2005 - H
F - MAR	2004 - G
G - APR	2003 - F
H - MAY	2002 - D
L - JUN	2001 - A
M - JUL	2000 - Z

The letter designating the year repeats every 12 years.

*Example:*

V - 2011  
V - 1999  
V - 1987

# Installation

## Anti-Tip Floor Bracket (on 21-ft. models)

### **⚠ WARNING**



Under certain circumstances, this refrigerator can tip forward.

Injury to persons can result.

Install Anti-Tip Bracket packed with this refrigerator.

### **1 MEASURE CABINET OPENING AVAILABLE VS. REFRIGERATOR WIDTH**

Measure width of cabinet opening where refrigerator will be placed, *W*.

Be sure to account for any countertop overhang, baseboard thickness and any clearance desired. Width, *W*, should not be less than 36 inches. The refrigerator will be placed approximately in the middle of this opening.

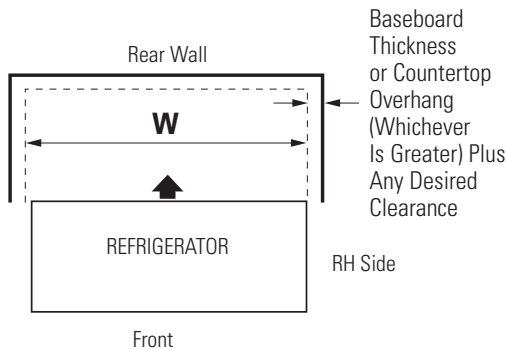

### **2 LOCATING THE ANTI-TIP FLOOR BRACKET**

- A** Place the anti-tip floor bracket locator template (included inside the anti-tip kit) onto the floor up against the rear wall, within *W*, and in line with the desired location of the RH side of the refrigerator (see Figure 1).

Figure 1 – Installation Overview

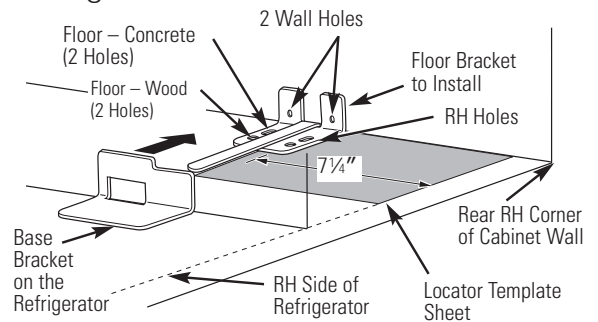

- B** Place the anti-tip floor bracket onto the locator template with its RH floor holes lined up with the floor holes indicated on the template sheet, approximately  $7\frac{1}{4}$ " from the edge of the sheet or the RH side of the refrigerator.
- C** Hold down in position and use the anti-tip floor bracket as a template for marking the holes based upon your configuration and type of construction as shown in Step 3. Mark the hole locations with a pencil, nail or awl.

#### **NOTE:**

- It is **REQUIRED** to use at least 2 screws to mount the floor bracket (one on each side of the anti-tip floor bracket). Both must be into either the wall or the floor. Figure 2 indicates all the acceptable mounting configurations for screws. Identify the screw holes on the anti-tip floor bracket for your configuration.

## 2 LOCATING THE ANTI-TIP FLOOR BRACKET (cont.)

Figure 2 – Acceptable Screw Placement Locations

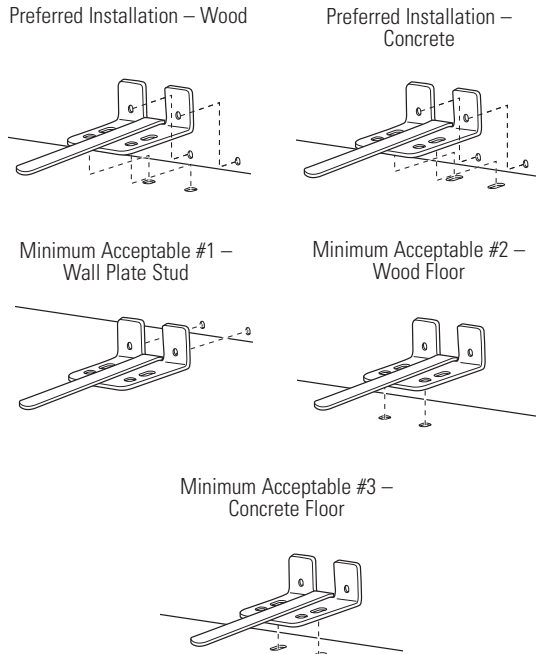

## 3 ANTI-TIP BRACKET INSTALLATION

- A** WOOD Wall and Floor Construction:
- Drill the appropriate number of 1/8" pilot holes in the center of each floor bracket hole being used (a nail or awl may be used if a drill is not available) AND remove the locator template from the floor.
  - Mount the anti-tip floor bracket by fastening the 2, or preferably 4, #10-16 hex-head screws tightly into place as illustrated in Figure 3.

Figure 3 – Attachment to Wall and Floor

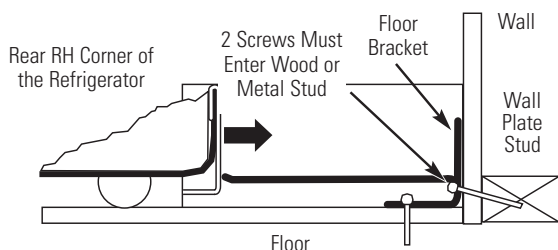

## **B** CONCRETE Wall and Floor Construction:

- Anchors required (not provided):  
4 each 1/4" x 1 1/2" lag bolts  
4 each 1/2" O.D. sleeve anchors
- Drill the recommended size holes for the anchors into the concrete at the center of the holes marked in Step 2.
- Install the sleeve anchors into the drilled holes. Place the anti-tip floor bracket as indicated in Step 2. Remove the locator template from the floor.
- Install the lag bolts through the anti-tip floor bracket and tighten appropriately.

## **C** WOOD Wall and TILE Floor Construction:

- For this special case, locate the 2 wall holes identified in Fig. 1. Drill an angled 1/8" pilot hole (approx. as shown in Fig. 3) in the center of each hole.
- Mount the anti-tip floor bracket using the Minimum Acceptable Installation #1, as illustrated in Fig. 2.

## 4 POSITIONING THE REFRIGERATOR TO ENGAGE THE ANTI-TIP FLOOR AND BASE BRACKETS

- A** Before pushing the refrigerator into the opening, plug the power cord into the receptacle and connect waterline (if equipped). Check for leaks.
- B** Locate the refrigerator's RH side and move back approximately in line with the RH side of the cabinet opening, W. This should position the anti-tip floor bracket to engage the anti-tip base bracket on the refrigerator.
- C** Gently roll the refrigerator back into the cabinet opening until it comes to a complete stop. Check to see if the refrigerator front lines up with the cabinet front face. If not, carefully rock the refrigerator forward and backward until engagement occurs and you notice that the refrigerator is fully pushed up against the rear wall.
- D** OPTIONAL: Adjust the rear (and front) wheel height settings to fully engage the rear anti-tip brackets, while also aligning the refrigerator front with the cabinet front face.

### NOTE:

If you pull the refrigerator out and away from the wall for any reason, make sure the anti-tip floor bracket is engaged when the refrigerator is pushed back against the rear wall.

# Control Features

## *About the controls with temperature settings.*

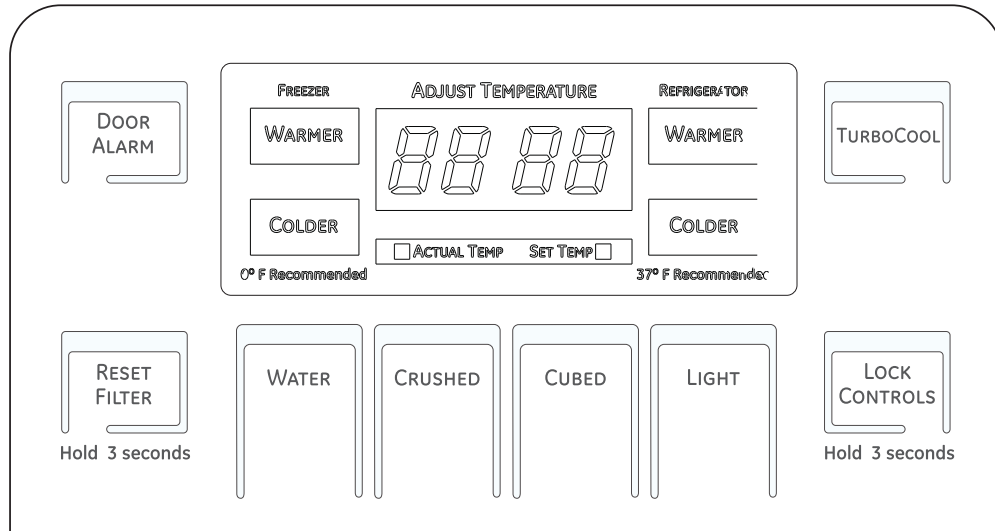

**Note:** The refrigerator is shipped with protective film covering the temperature controls. If this film was not removed during installation, remove it now.

The temperature controls are preset in the factory at 37°F for the refrigerator compartment and 0°F for the freezer compartment. Allow 24 hours for the temperature to stabilize to the preset recommended settings.

The temperature controls can display both the SET temperature as well as the actual temperature in the refrigerator and freezer. The actual temperature may vary slightly from the SET temperature based on usage and operating environment.

Setting either or both controls to **OFF** stops cooling in both the freezer and refrigerator compartments, but does not shut off electrical power to the refrigerator.

**To turn the cooling system off**, tap the refrigerator **WARMER** touch pad until the temperature display flashes and beeps. Then tap the freezer **WARMER** touch pad until the display indicates **OFF** and beeping stops.

**To turn the cooling system on**, tap the refrigerator **COLDER** touch pad twice. The display will also show the refrigerator and freezer temperature settings.

## Door Alarm

The door alarm will sound and the door alarm LED will be flashing if any door/drawer is open for more than 2 minutes. When you close the door/drawer, the beeping stops and the LED will reset to full on.

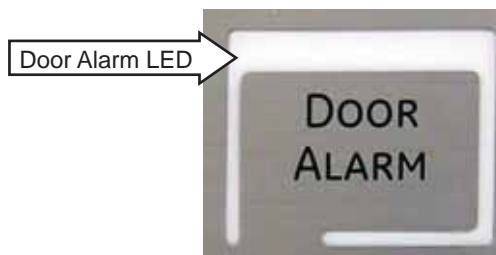

## Energy Saver (If Available)

Some products are equipped with an energy saver pad and LED. The refrigerator is shipped with the energy saver feature enabled.

Over time, moisture can form on the front surface of the refrigerator cabinet and cause rust. If moisture does appear on the front surface of the refrigerator cabinet, turn off the energy saver feature (if available) by pressing and releasing the **ENERGY SAVER** pad on the control panel.

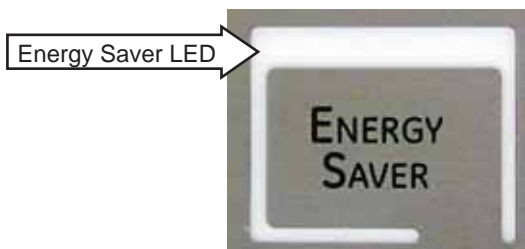

## Dispenser Light

This pad turns the night light in the dispenser on and off. The light also comes on when the dispenser cradle is pressed.

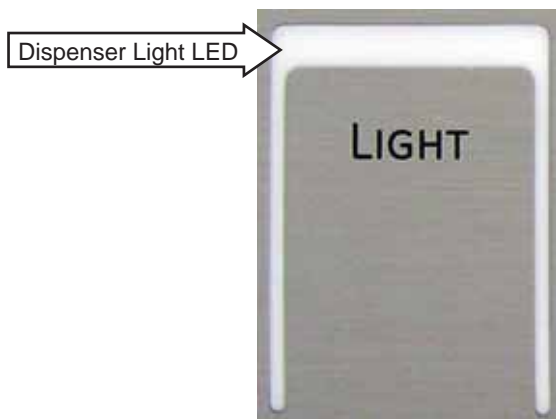

## TurboCool™

### How it Works

TurboCool™ rapidly cools the refrigerator compartment in order to more quickly cool foods. Use TurboCool when adding a large amount of food to the refrigerator compartment, putting away foods after they have been sitting out at room temperature, or when putting away warm leftovers. It can also be used if the refrigerator has been without power for an extended period.

Once activated, the compressor will turn on immediately and the fans will cycle on and off at high speed as needed for 8 hours. The compressor will continue to run until the refrigerator compartment cools to approximately 34°F, then it will cycle on and off to maintain this setting. After 8 hours, or if **TURBOCOOL** is pressed again, the refrigerator compartment will return to the original setting.

### How to Use

Press the **TURBOCOOL** pad. The refrigerator temperature display will show **EC**.

After TurboCool is complete, the refrigerator compartment will return to the original setting.

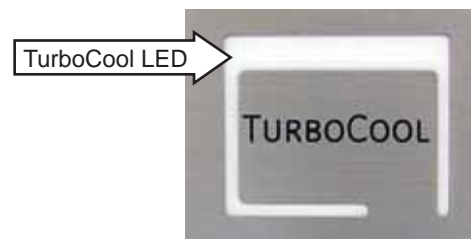

### Note:

- The refrigerator temperature cannot be changed during TurboCool.
- The freezer temperature is not affected and can be changed during TurboCool.
- When opening the refrigerator door during TurboCool, the fans will continue to run if they have cycled on.

## Dispensing Functions

The water function is controlled by the main control board. To select this function, press the cradle on the dispenser.

### Dispenser Lock

When the dispenser system is locked, no dispenser command will be accepted. This includes the dispenser cradle and will prevent accidental dispensing that may be caused by children or pets. If a pad or the cradle is depressed with the system locked, it will be acknowledged with 3 pulses of the LOCK LED accompanied by an audible tone.

To lock or unlock communication between the dispenser and main control board, press the **LOCK** pad and hold it for 3 seconds. The LOCK LED will flash while the **LOCK** pad is pressed. When the communication is locked, the LOCK LED will be illuminated. Pressing any **WARMER** or **COLDER** touch pad will display actual temperatures. Set temperatures cannot be changed.

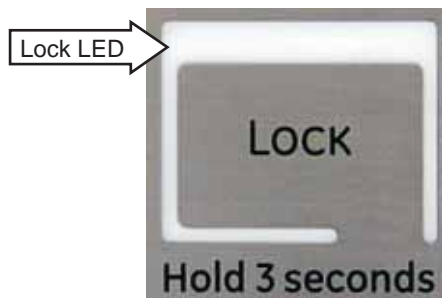

The lock feature will be restored in the event of a power disruption.

### Showroom Mode

Showroom Mode disables the cooling system.

To enter Showroom Mode (on some models), press any pad on temperature display, and then press **FREEZER COLDER** and **REFRIGERATOR WARMER** touch pads for 3 seconds, (control beeps once).

To exit, unplug the refrigerator for 3 seconds, and then reconnect power.

## Defrost Cycle

The refrigerator utilizes an adaptive defrost cycle that operates a glass-enclosed heater to remove frost from the evaporator. The defrost cycle has changed from 60 hours adaptive defrost to anywhere between 8 and 96 hours adaptive defrost.

The control board determines the length of time the heater is energized. It does this by monitoring the defrost heater relay mounted on the main board. Once the temperature of the thermistor reaches 50°F, the control cycles the defrost heater off. A bi-metal safety thermostat provides a backup in the event the evaporator thermistor fails. The safety thermostat prevents the temperature from exceeding 140°F.

**Note:** Refer to Pub# 31-9062 for information about basic adaptive defrost.

### Liner Protection Mode

The refrigerator incorporates a liner protection mode for the freezer section. The freezer evaporator and ice box fans will start and run on low speed if any door or drawer has been open for 3 minutes. Air will circulate into the fresh food section if the damper is in the open position.

This mode is controlled by 2 timers. Timer #1 monitors door/drawer-open time. A 3-minute door/drawer-open count begins when a door/drawer is opened. If 3 minutes elapse before the door/drawer is closed, the liner protection mode will become active. Once the door/drawer is closed, timer #1 resets and liner protection mode goes into standby. In standby, normal fan operation resumes and timer #2 begins a 3-minute door/drawer-closed count. If 3 minutes elapse without a door/drawer opening, liner protection mode will completely deactivate. If a door/drawer is opened within the timer #2 door/drawer-closed count, the remaining time in the door/drawer-closed count will be deducted from the timer #1 door/drawer-open count.

## About the Water Filter.



### Water Filter Cartridge

The water filter cartridge is located in the back upper right corner of the refrigerator compartment.

### When to Replace the Filter

There is a replacement indicator light for the water filter cartridge on the temperature display. This light will turn orange to tell you that you need to replace the filter soon. The filter cartridge should be replaced when the replacement indicator light turns red or if the flow of water to the dispenser or icemaker decreases.

### Installing the Filter Cartridge

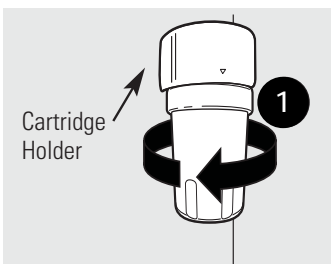

- 1 If you are replacing the cartridge, first remove the old one by slowly turning it to the left. **DO NOT** pull down on the cartridge. A small amount of water may drip down.

**!** **Caution:** If air has been trapped in the system, the filter cartridge may be ejected as it is removed. Use caution when removing.

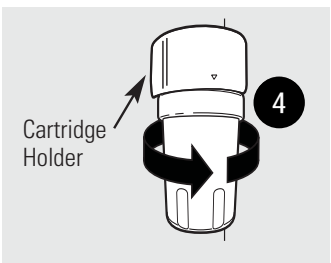

- 2 Remove the protective foil from the end of the cartridge.
- 3 Fill the replacement cartridge with water from the tap to allow for better flow from the dispenser immediately after installation.

- 4 Lining up the arrow on the cartridge and the cartridge holder, slowly rotate the cartridge clockwise until it stops. When the cartridge is properly installed, you will feel it "click" as it locks into place. **Do not overtighten.**

- 5 Run 1½ gallons (about 3 minutes) from the dispenser to clear the system and prevent sputtering.

- 6 Press and hold the **RESET WATER FILTER** pad for 3 seconds.

**Note:** A newly-installed water filter cartridge may cause water to spurt from the dispenser.

### Filter Bypass Plug

You must use the filter bypass plug when a replacement filter cartridge is not available. The dispenser and the icemaker will not operate without the filter or filter bypass plug.

### Replacement Filters:

For the maximum benefit of your filtration system, GE recommends the use of GE branded SmartWater filters only. Using GE branded filters in GE and Hotpoint refrigerators provides optimal performance and reliability. GE branded

SmartWater filters are always the right choice because they are patented and designed specifically for GE products. GE SmartWater filters meet rigorous industry NSF standards for safety and quality that are important for products that are filtering your water. GE has not qualified non-GE branded filters for use in GE and Hotpoint refrigerators and there is no assurance that non-GE branded filters meet GE's standards for quality, performance and reliability.

To order additional filter cartridges in the United States, visit our Website, [GEAppliances.com](http://GEAppliances.com), or call GE Parts and Accessories, 800.626.2002.

Filter Model MWF

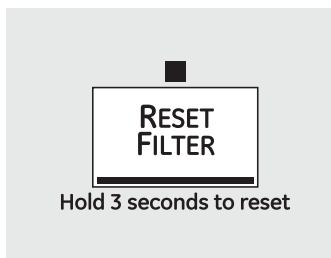

(Continued next page)

## About the Icemaker.

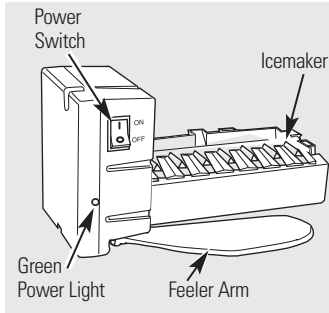

The icemaker will produce seven cubes per cycle— approximately 100–130 cubes in a 24-hour period, depending on freezer compartment temperature, room temperature, number of door openings and other use conditions.

See below for how to access ice and reach the power switch.

If the refrigerator is operated before the water connection is made to the icemaker, set the power switch in the O (off) position.

When the refrigerator has been connected to the water supply, set the power switch to the I (on) position. The icemaker power light will turn green when the freezer light switch is pressed in or when the freezer door is closed.

The icemaker will fill with water when it cools to 15°F. A newly installed refrigerator may take 12 to 24 hours to begin making ice cubes.

You will hear a buzzing sound each time the icemaker fills with water.

Throw away the first few batches of ice to allow the water line to clear.

Be sure nothing interferes with the sweep of the feeler arm.

When the bin fills to the level of the feeler arm, the icemaker will stop producing ice. It is normal for several cubes to be joined together.

If ice is not used frequently, old ice cubes will become cloudy, taste stale and shrink.

### Note:

- In homes with lower-than-average water pressure, you may hear the icemaker cycle multiple times when making one batch of ice.
- Set the power switch to the O (off) position if the water supply is shut off.
- When replacing the IM use only the originally electronic IM part number.

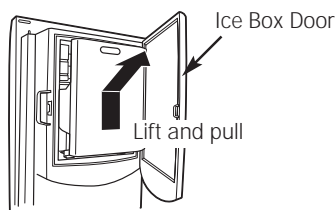

### Accessing Ice and Reaching the Power Switch

To reach the icemaker power switch and access ice, open the ice box door located on the refrigerator door and remove the bucket.

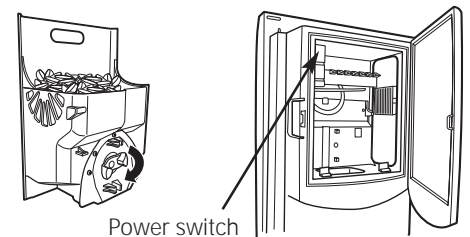

### Ice Bucket and Dispenser

- Pull up and out on the ice bucket to remove it from the compartment.
- To replace the ice bucket, set it on the guide brackets and push until the ice bucket seats properly.
- If bucket cannot be replaced, rotate the Ice Bucket Fork 1/4 turn clockwise.

### Extra Ice Storage

- There is additional ice storage in the freezer compartment drawer.

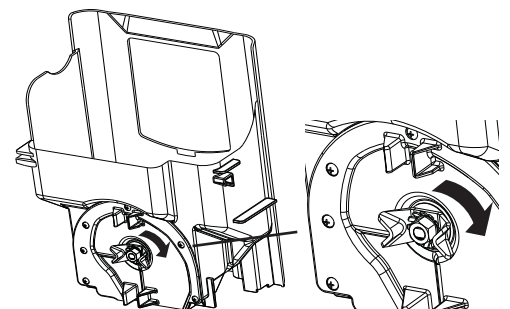

## Deli Pan Removal

### How to Remove and Replace the Deli Pan

To remove:

- 1 Remove the fruit and vegetable drawers.
- 2 Remove the Deli Pan cover.
- 3 Pull the drawer out to the stop position.
- 4 Lift the lid to access the 4 swing locks.
- 5 Rotate all four swing locks to the unlock position.
- 6 Lift the front of the drawer up and out.

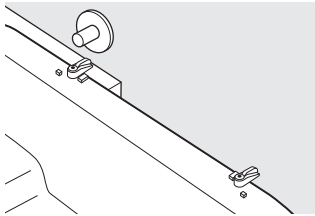
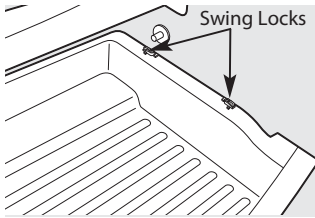
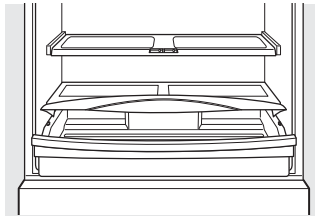

To replace:

- 1 Make sure all four swing locks are in the unlock position.
- 2 Place the sides of the drawer into the drawer supports, making sure the swing locks fit on the drawer slots.
- 3 Lock all four swing locks by rotating them to the lock position.

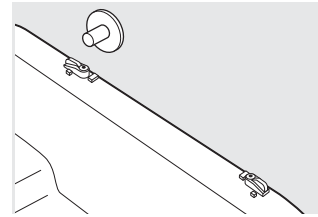

- 4 Lower the lid and slide in the drawer.
- 5 Replace the fruit and vegetable drawers.

# Control Board Connector Locator

## Main Control Board



J10 and J13 - Earth (Ground)

J8 - Air Duct Heater, Supply Duct Heater

J9 - Defrost Heater, Over-temperature Thermostat, Return Duct Heaters

J11 - Line (L1)

J7 - Auger Motor, Dispenser Water Valve, Duct Port Heater, Freezer Interlock Switches, Top Drawer and Bottom Drawer Light Switches

J12 - Double Door Mullion Heater, Fresh Food/Freezer Mullion Heater

J18 - Icemaker Water Valve (Automatic Quick Ice)

K3 - Water

K4 - Defrost

J15 - Inverter

J14 - Freezer and Fresh Food LED Lighting

J2 - Fan Common, Evaporator Fan, Condenser Fan, Air Duct Blower, Mullion Bar Heater

J5 - Humidity Sensor, LED Lighting

J4 - Display Board

J3 - Damper

J1 - Fresh Food Thermistor, Ambient Thermistor, Freezer Thermistor, Evaporator Thermistor, Model Selector

## Dispenser Board

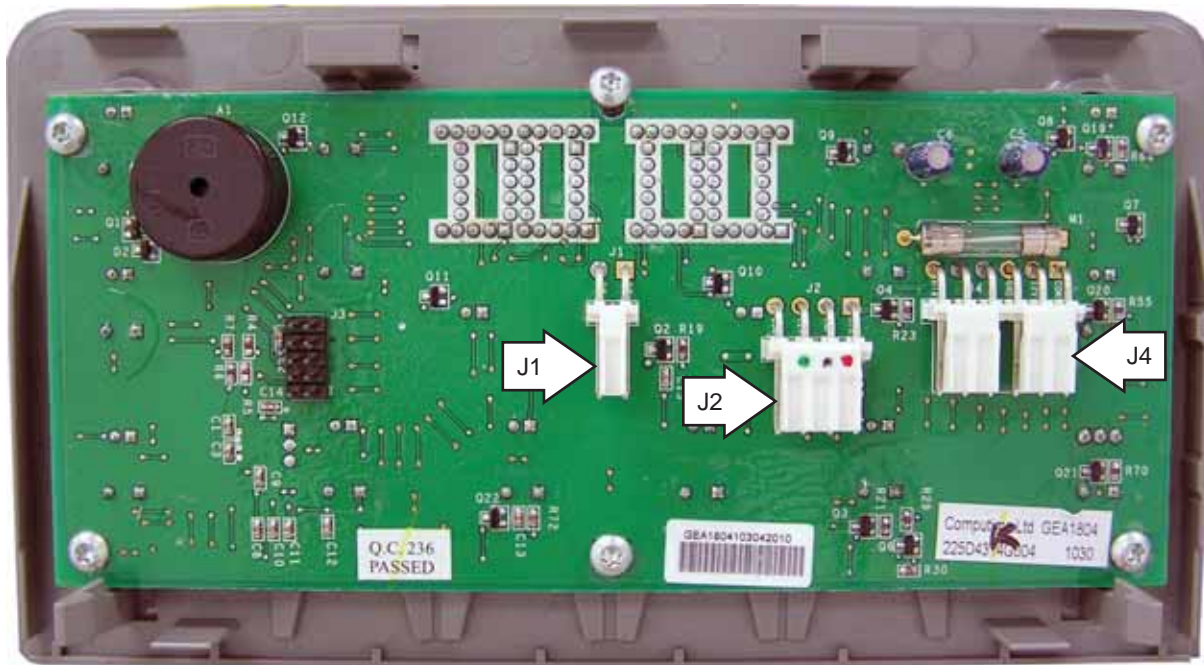

J1 - Duct Door Solenoid

J2 - Dispenser LED Light, BS PCB Switch (Dispenser Cradle Switch)

J4 - 13 VDC Supply, Access Heater, Duct Gasket Heater, Duct Door Heater, EMI Filter

# Components Locator Views

## Fresh Food Compartment

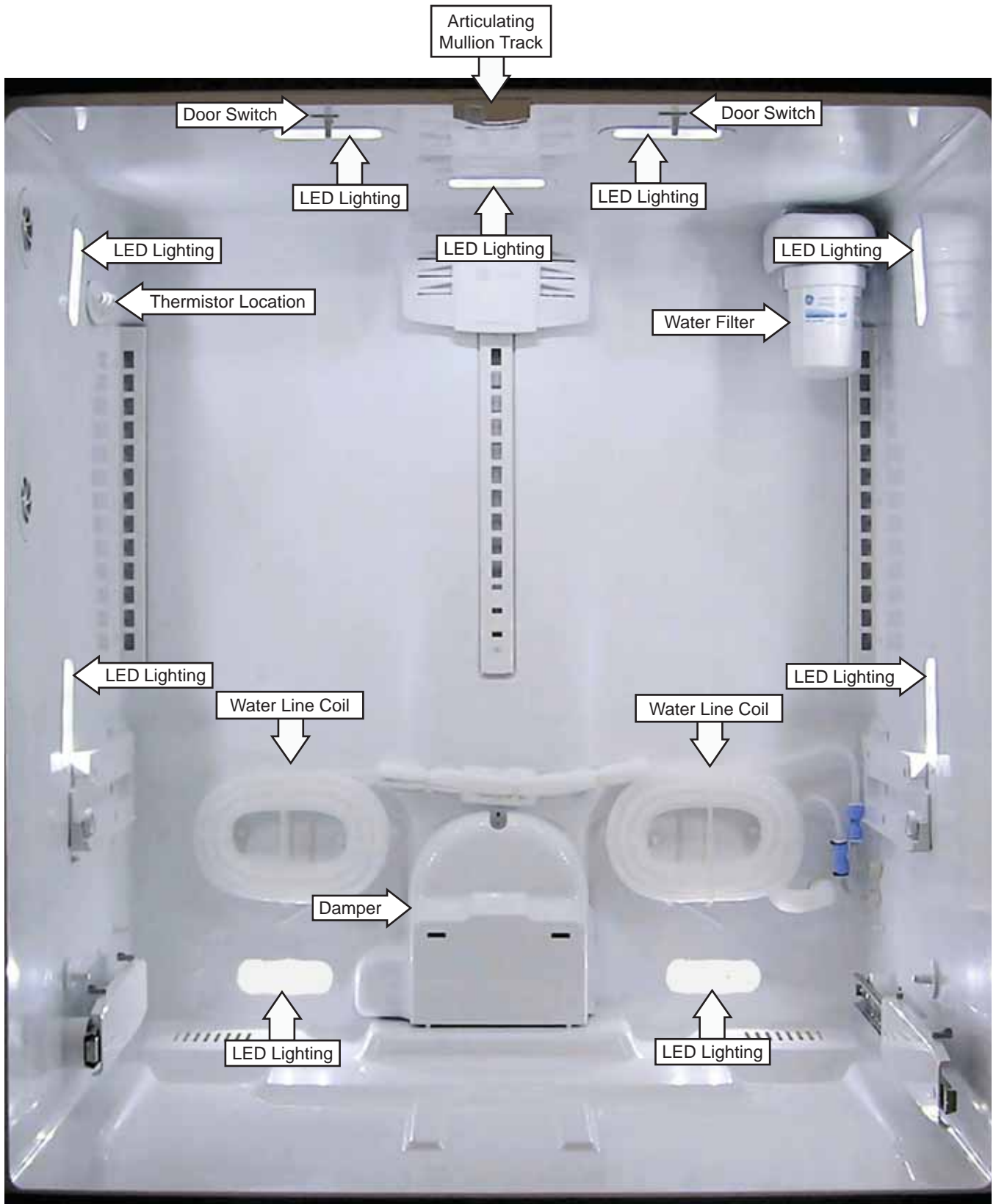

Freezer Compartment - (double drawer model shown)

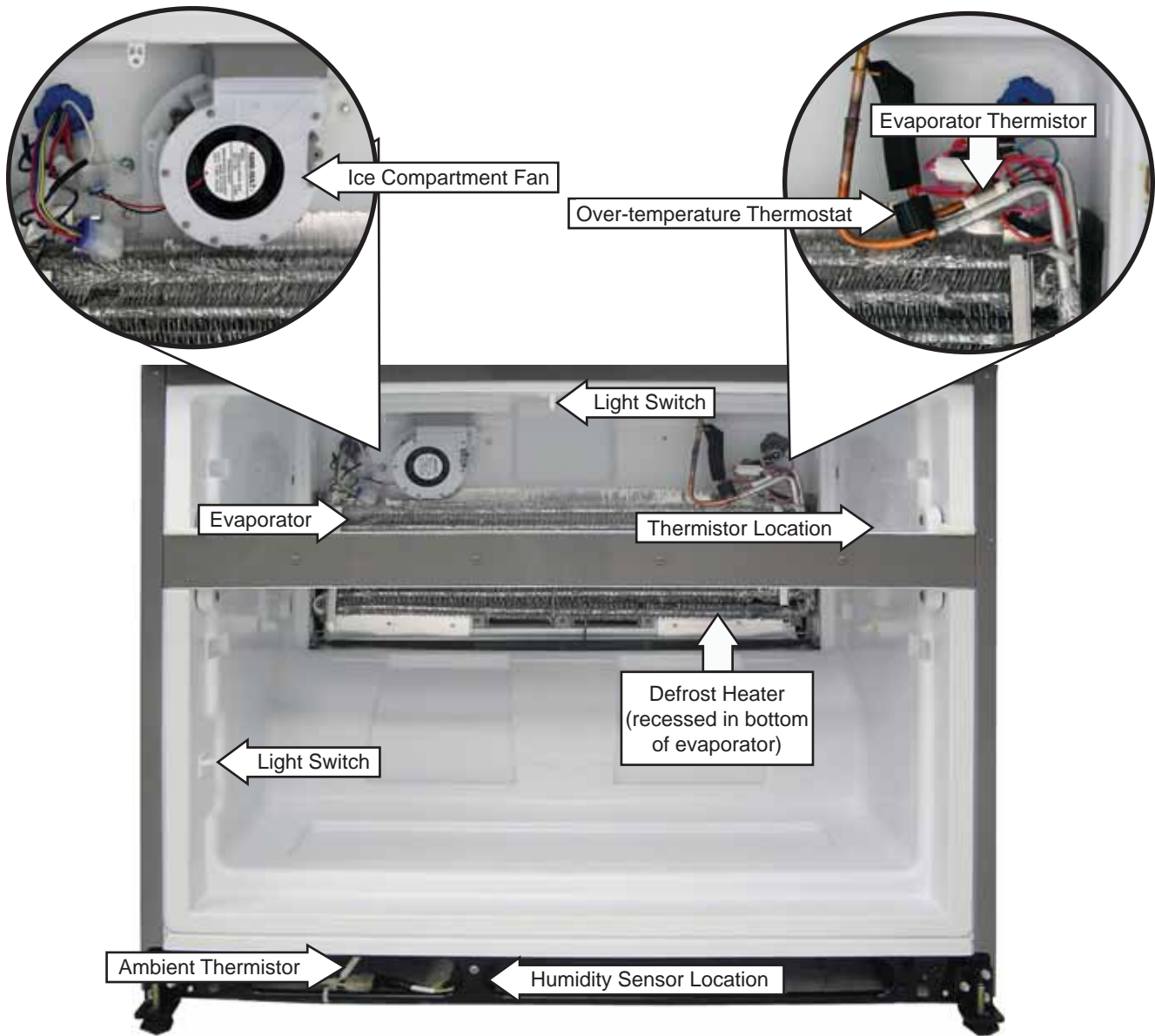

Rear View

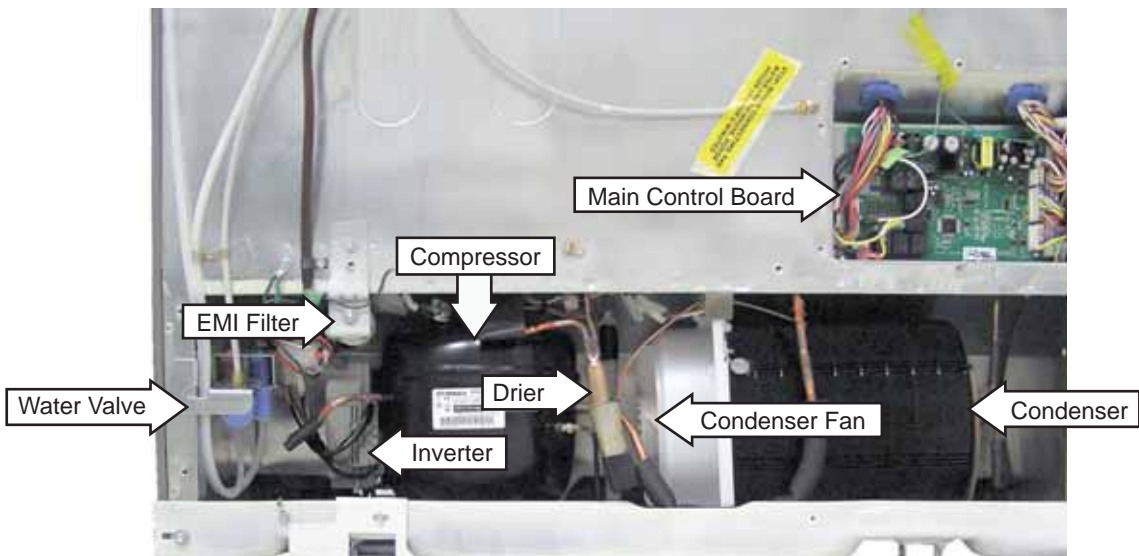

# Refrigeration System

## Refrigeration Components

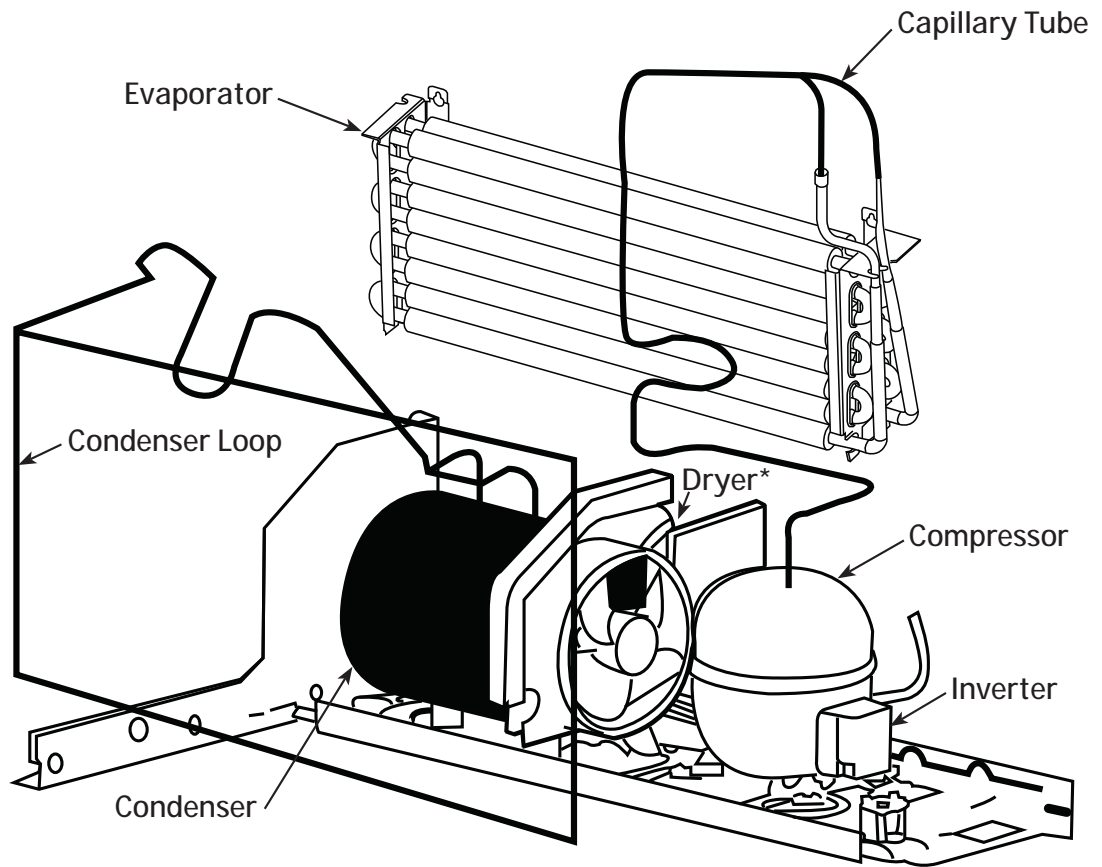

\*The dryer (not shown), is vertically positioned between the compressor and the condenser fan motor.

# Airflow

## Refrigerator Airflow - (double drawer model shown)

The evaporator fan forces air through the evaporator into the freezer compartment.

Air from the evaporator can also pass through the electronic damper to the air tunnel outlet, through the fresh food compartment, and return to the evaporator.

The damper is controlled by the main control board. When open, the damper allows the chilled air from the freezer to move into the fresh food compartment.

Air returns from the fresh food compartment to the freezer compartment via 2 vents located to the left and right of the electronic damper.

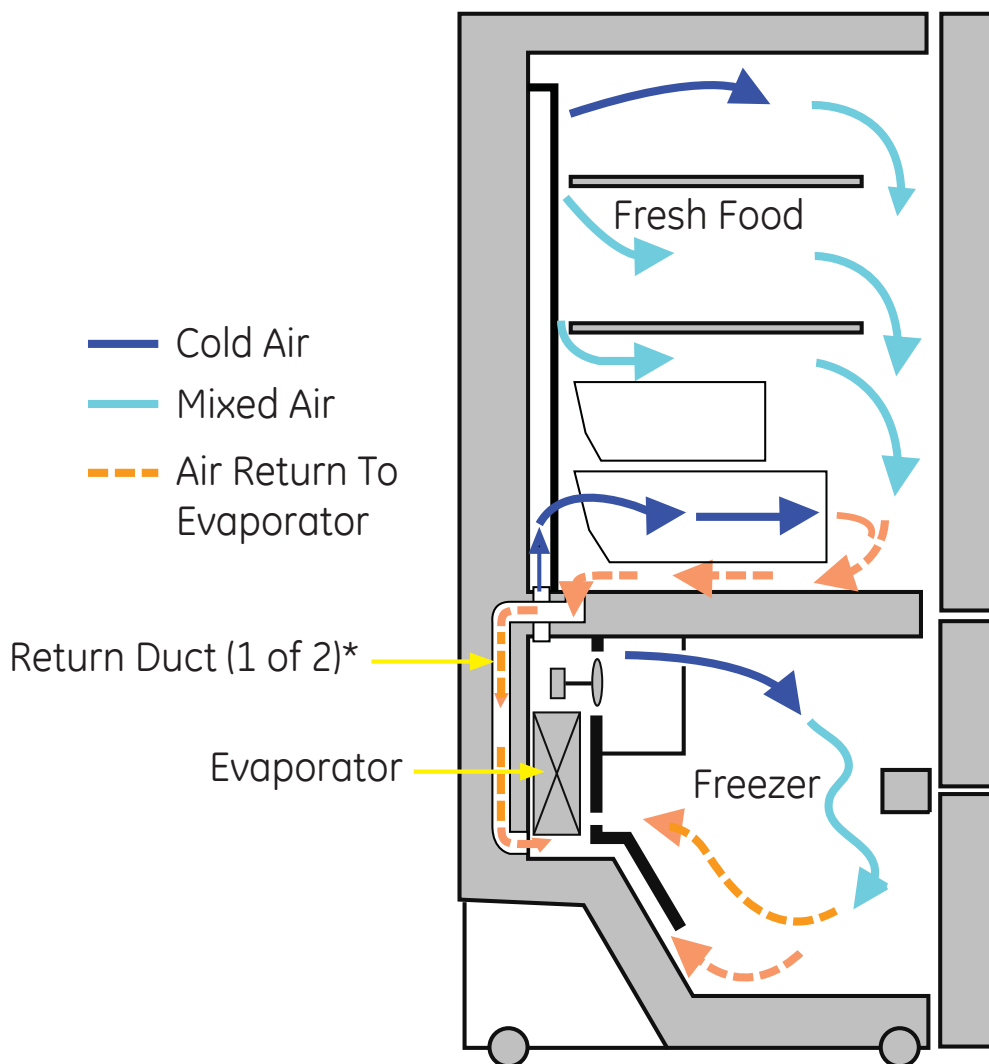

\*Return air ducts are located in the freezer liner behind the evaporator and are not replaceable.

## Ice System Airflow - (single drawer model shown)

The ice fan forces air up from the freezer into the ice door section via an inlet duct.

The ice fan is controlled by the main control board.

Air returns from the ice door section to the freezer compartment via an outlet duct.

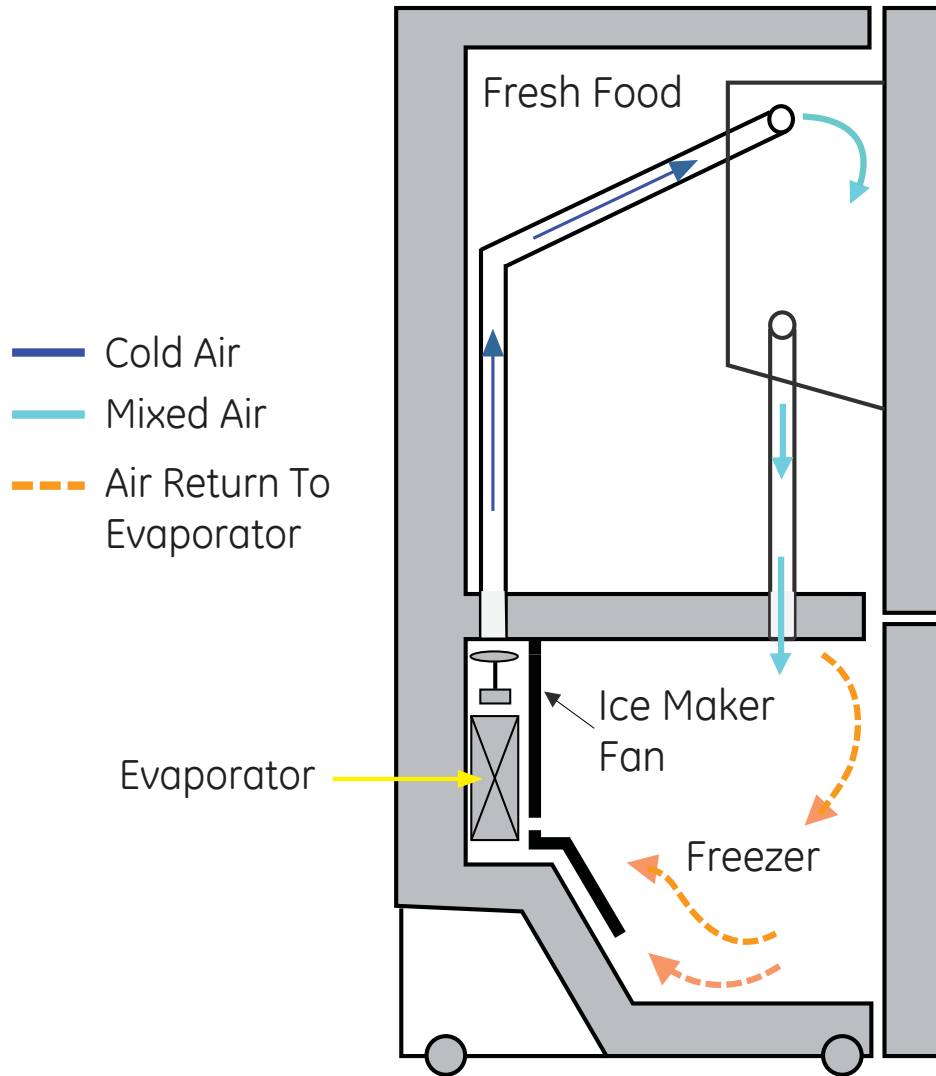

# Components

## Freezer Drawer/Fresh Food Door Handles

**Note:** Each freezer drawer handle is held in place by a left and a right 1/8-in. Allen set screw. Each fresh food door handle is held in place by a top and a bottom 3/32-in. Allen set screw. When tightened, the set screws lock the handle to mounting fasteners located behind the handle and attached to the drawer or door panel.

Using an Allen wrench, loosen the 2 recessed screws, and then pull the handle straight out from the drawer or door panel.

**Note:** If the handle mounting fasteners need to be tightened or removed, use a 3/16-in. Allen wrench.

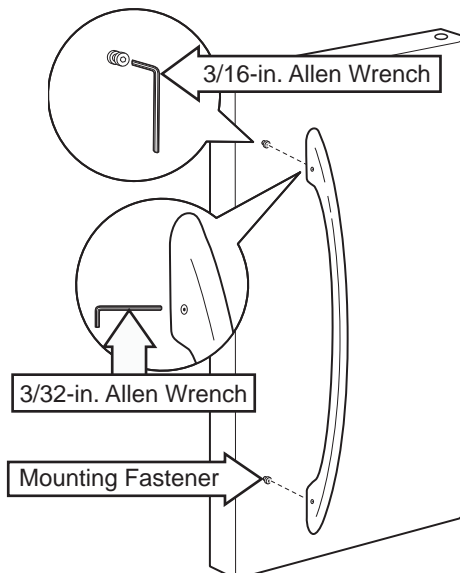
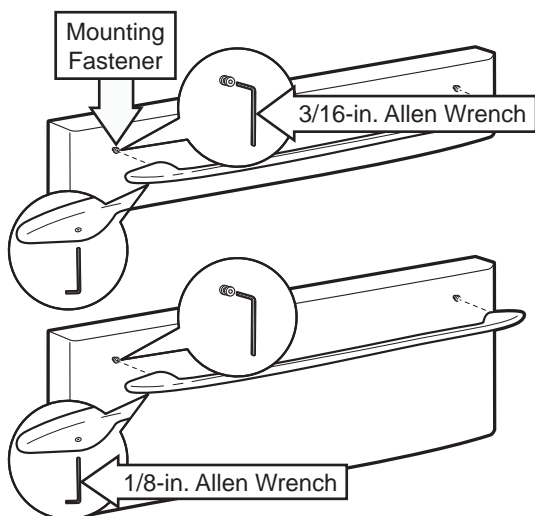

## Door Closure Mechanisms

### Fresh Food Doors

The closure mechanism for each fresh food door consists of a hinge closure assembly attached to the top of the cabinet that interacts with a cam attached to the top of each door.

To access the hinge closure assembly, it is necessary to remove the Phillips-head screw and the cover from the top of the hinge closure assembly.

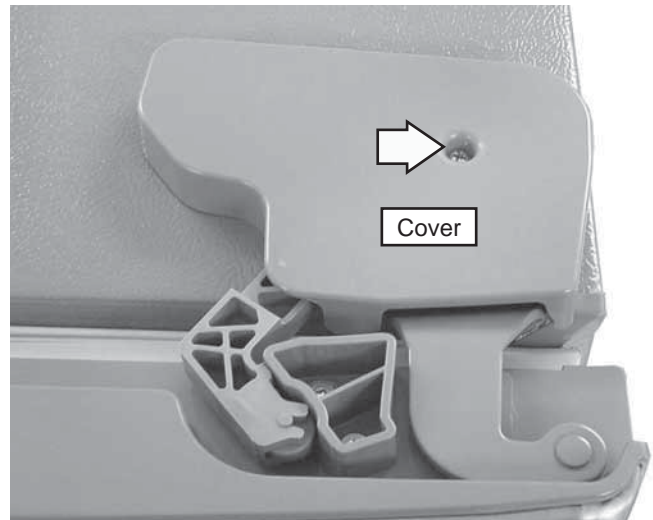

The hinge closure assembly is held to the top of the cabinet with two 5/16-in. hex-head screws. The cam is attached to the top of the door with two T-20 Torx screws.

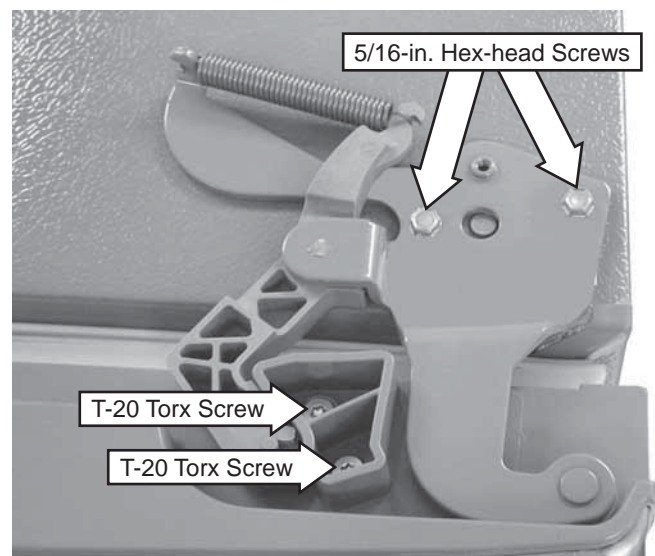

*(Continued next page)*

Before removing the left-side door hinge, it will also be necessary to remove the 1/4-in. hex-head screws that attach the ground wire to the hinge and the wire harness retainer to the cabinet top.

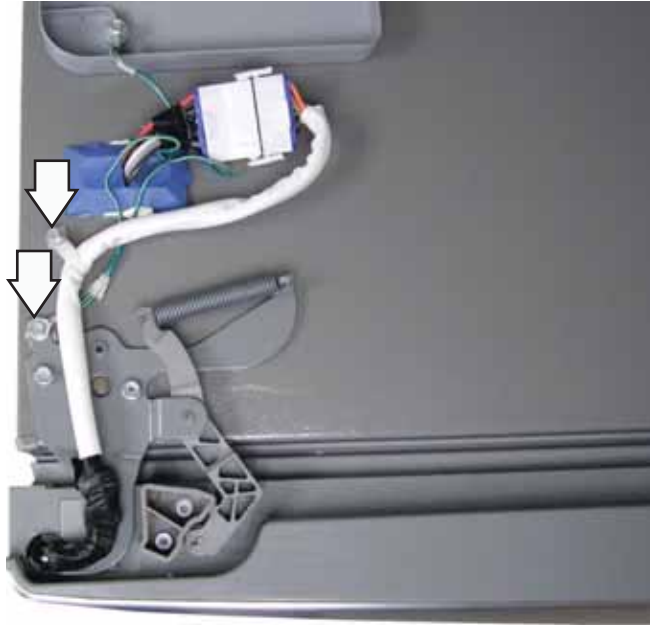

After removing the two 5/16-in. hex-head screws and lifting the hinge, the wiring can be passed through the opening in the hinge.



## Door Alignment

If the top of the doors are uneven, first try to raise the lowest door by turning the leveling leg on the same side as the door until the doors are even. If the unit rocks, re-adjust the leveling legs until the unit is stable.

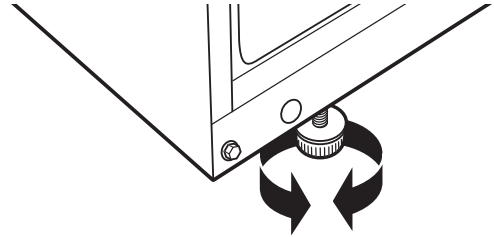

If the doors remain uneven, turn the adjustable pin to raise or lower the right door to match the left door. Use a 1/4-in. Allen wrench to turn the pin.



## Freezer Drawer Closure Mechanisms

The freezer drawers utilize 2 closure mechanisms that automatically pull the drawer shut when it is within 1 inch of the closed position. The mechanisms are built into the 2 drawer slide assemblies and are not replaceable as a separate part.

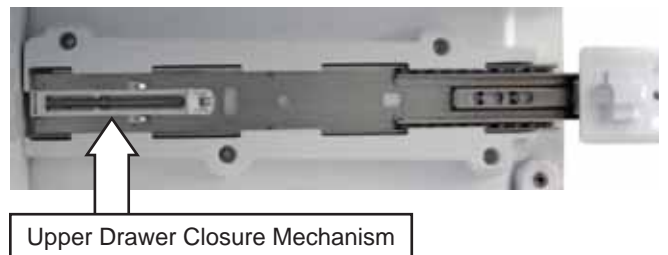

## Fresh Food Door Removal

### To remove the fresh food door:

1. Open the top freezer drawer.

#### Note:

- The following procedure applies to removing the left-side door with dispenser. Follow this same procedure for removing the right-side door. There are no wires, water lines, or center hinge covers on the right-side door.
  - If removing the left-side door, it may be helpful to reduce weight by removing the ice bucket from the door.
2. Remove the screw securing the center hinge cover.
  3. Pull the right side of the hinge cover out and remove the cover from the hinge.



4. Using a flat blade screwdriver, push down and remove the metallic water line support from each water line.



5. Using a flat blade screwdriver, push the red plastic lock clip off each water line collar.
6. Disconnect the door wire harness.

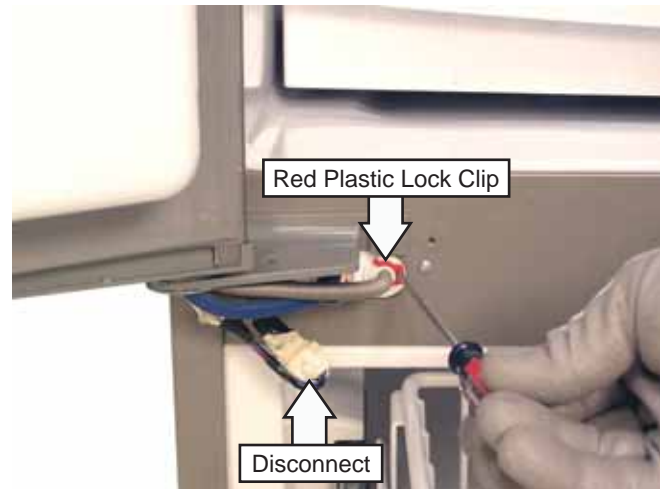

7. Carefully push the collar in while pulling each water line out from the coupling.

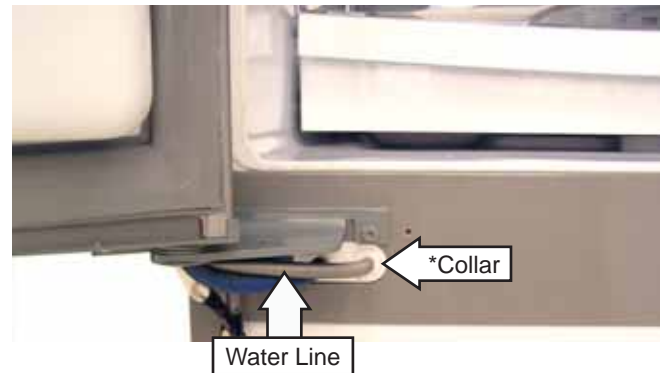

\*Replacement collar unavailable

**Note:** The red plastic clip and the water line for the icemaker is smaller than the clip and the water line for the dispenser.

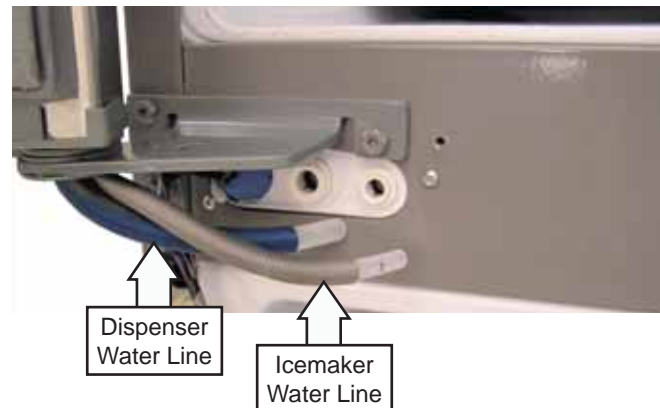

*(Continued next page)*

8. Remove the hinge cover on top of the refrigerator door by removing the Phillips-head screw and pulling it up.

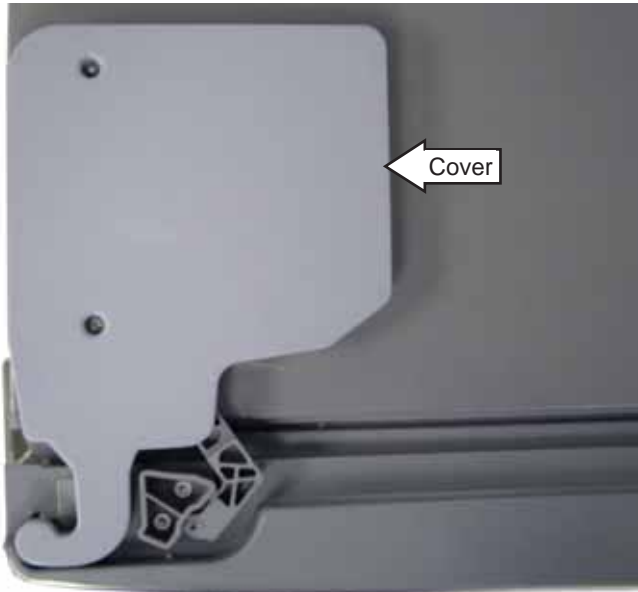

9. Disconnect the door wire harness.
10. Remove the 1/4-in. hex-head screw from the harness retainer.
11. Remove the 1/4-in. hex-head screw that attaches the ground wire to the hinge.
12. Remove the two 5/16-in. hex-head screws that attach the top hinge to the cabinet.

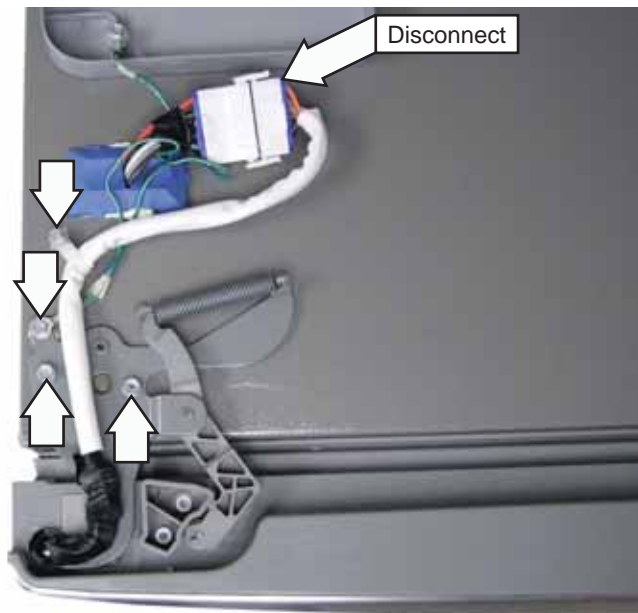

13. If removing the left-side door, open the right-side door.
14. Tilt the door away from the cabinet. Lift the door off the center hinge pin and carefully guide the water lines and wire harness through the opening in the center hinge.

**Note:** Ensure that the plastic hinge pin thimble remains on the hinge pin or inside door hinge pin hole located in the bottom of the door.



15. Place the door on a protective surface with the inside up.

## Top Freezer Drawer

### Freezer Basket

1. Open the top freezer drawer until it stops.
2. Lift the front end of the basket until the front 2 alignment tabs come out of the front plastic inserts located in the slide assemblies.
3. Rotate the front edge of the drawer up while lifting the remaining 2 rear alignment tabs out of the rear plastic inserts located in the slide assemblies. Pull the basket up and out of the drawer.

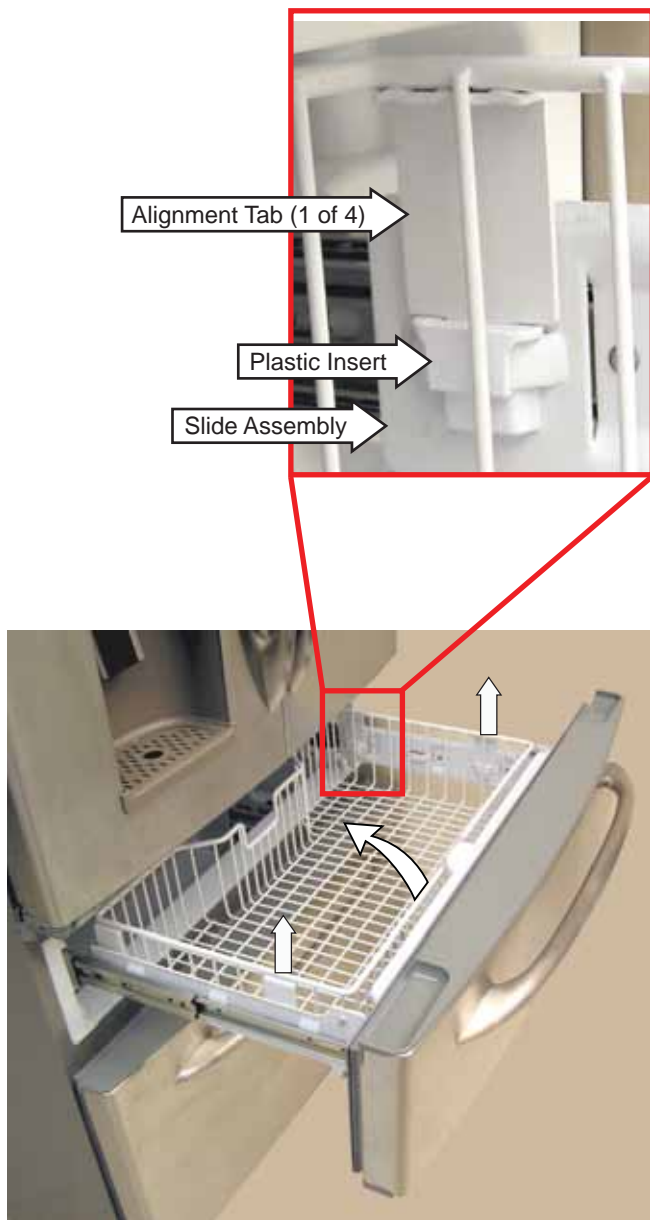

### Drawer Vertical Adjustment

**Note:** This following instruction is for adjusting the upper drawer front vertically to meet appearance needs of the customer. Both the right- and left-side of the drawer front can be adjusted independently.

#### To adjust the drawer vertically:

1. Remove the freezer basket. (See Freezer Basket, this section.)
2. Remove the pilot screw on the side of the drawer front that needs to be adjusted. Do one side at a time if both need adjustment.
3. Loosen 3 full turns the remaining three 10-mm hex-head screws on the side that needs to be adjusted.
4. Raise or lower the side of the drawer front requiring adjustment to the desired position. Once positioned, tighten the 3 screws.

**Note:** Do not replace the pilot screw once the drawer front is adjusted. It is no longer needed.

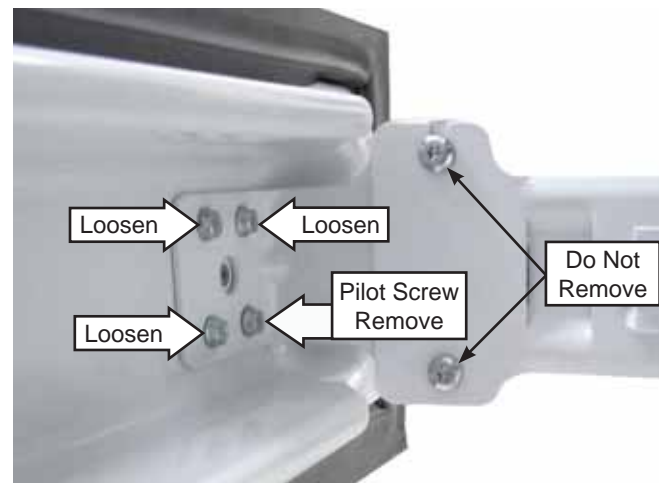

Left Side Bracket Shown

### Drawer Panel Removal

#### To remove the drawer panel:

1. Remove the freezer basket. (See Freezer Basket, this section.)
2. Remove the four 10-mm hex-head screws (4 on each side) that attach the drawer panel to each drawer bracket.

## Drawer Removal

To remove the drawer:

1. Remove the freezer basket. (See Freezer Basket, this section.)
2. Loosen (do not remove) the T-30 Torx screw at the top of the left side slide assembly.
3. Remove the two T-30 Torx screws from the bottom of each slide assembly.

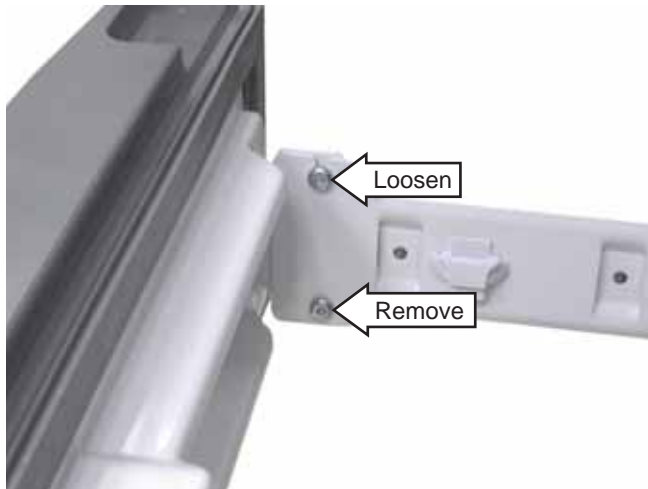

Left Side Bracket Shown

4. Tilt the drawer panel 45 degrees out from the bottom, and then lift up and remove the drawer from the slide assemblies.



5. Push the slide assemblies back into the cabinet.

## Bottom Freezer Drawer

### Freezer Basket

1. Open the bottom freezer drawer until it stops.
2. Pull the divider forward until the rear locating tabs are out of the slots. Turn the divider slightly to the side to release the front locating tabs and lift out.

**Note:** The freezer basket front section rests on the metal slide brackets and is held in place with swing locks.

3. Turn the swing locks from vertical to horizontal position. Open fresh food doors.
4. Lift the basket front section up and rotate it toward you. Slide out from the side of the drawer.
5. Lift the basket rear section from the metal slide brackets.

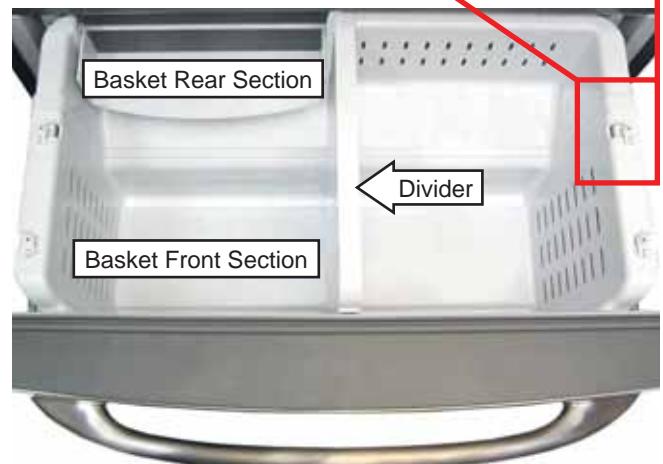

## Drawer Vertical Adjustment

**Note:** This following instruction is for adjusting the lower drawer front vertically to meet appearance needs of the customer. Both the right- and left-side of the drawer front can be adjusted independently.

### To adjust the drawer front vertically:

1. Remove the freezer basket. (See Freezer Basket, this section.)
2. Loosen 3 full turns the four T-30 Torx screws on the side that needs to be adjusted. Do one side at a time if both need adjustment.
3. Turn the Phillips-head adjustment screw clockwise to lower the drawer or counterclockwise to raise the drawer to the desired position. Once positioned, tighten the four T-30 Torx screws.

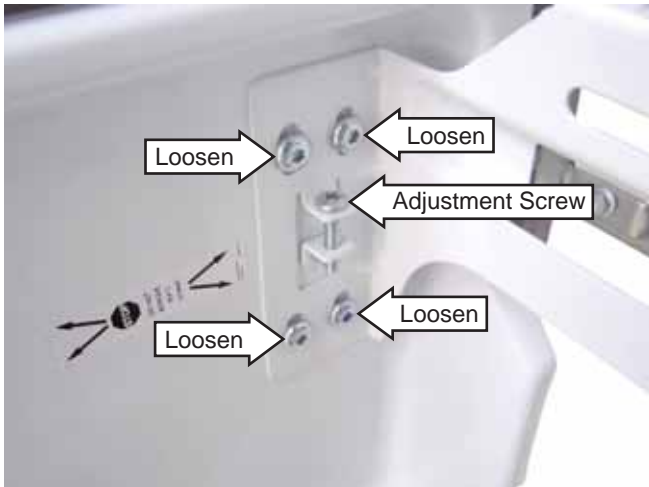

Left Side Bracket Shown

## Drawer Panel Removal

### To remove the drawer panel:

1. Remove the freezer basket. (See Freezer Basket, this section.)
2. Remove the Phillips-head adjustment screws (1 on each side).
3. Remove the four T-30 Torx screws (4 on each side) that attach the drawer panel to each drawer bracket.

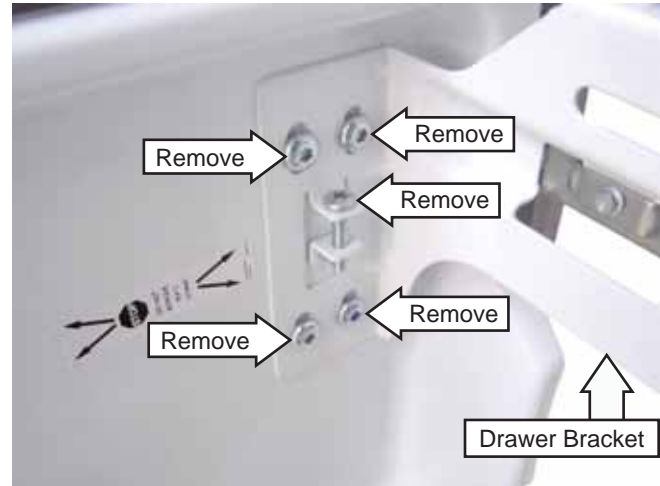

(Continued next page)

## Drawer Removal

To remove the drawer:

1. Remove the freezer basket. (See Freezer Basket, this section.)
2. Remove the two 1/4-in. hex-head screws (1 on each side) that attach each drawer bracket to each track.

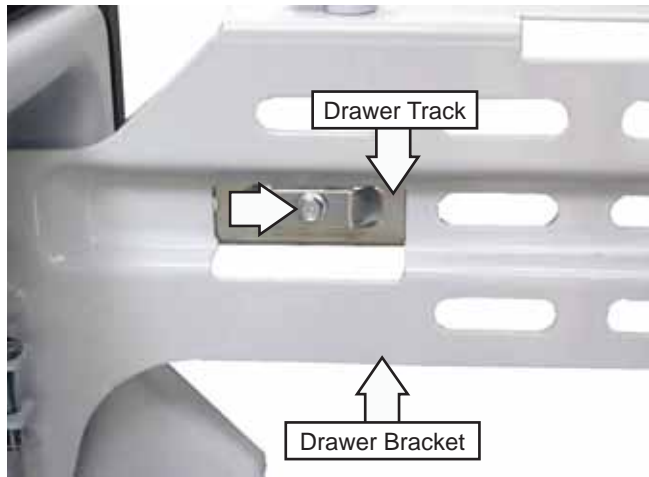

3. Lift up and disengage the drawer from the rear slot on each track assembly.

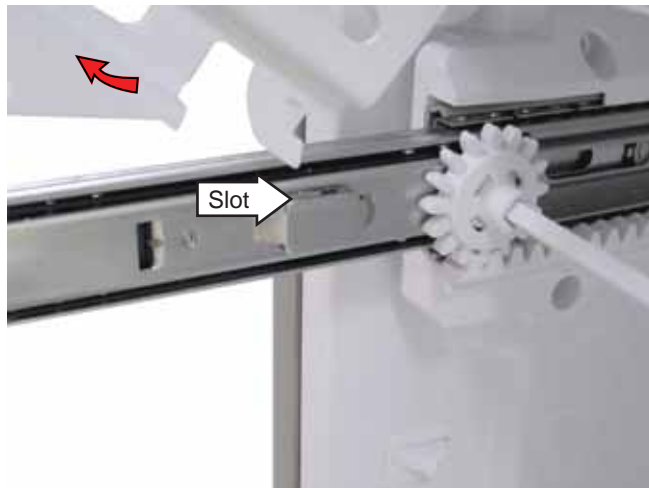

Left Side Track Assembly Shown

## Door and Drawer Gaskets

The fresh food and freezer drawers have magnetic gaskets that create a positive seal to the front of the steel cabinet. The ice dispenser door is sealed by a non-magnetic gasket attached to the back of the ice dispenser cavity. The gaskets are secured by a barbed edge that locks into a retainer channel.

### To remove and replace the gasket:

1. Starting at any corner, pull the old gasket out of the retaining channel.
2. Soak the new gasket in warm water to make it pliable.
3. Push the barbed edge of the gasket into the retainer channel.



Fresh Food Door Gasket



Dispenser Door Gasket

## Ice Compartment

### Ice Operation – Basic Logic

The new Profile Bottom Mount Ice and Water Refrigerators have multiple unique logic and calculations that are accomplished with the board, the control settings, and feedback from thermistors.

However, the new ice door does not have its own thermistor, and therefore calculations are accomplished with input from the fresh food and freezer thermistors.

A dedicated blower fan circulates cold air from the freezer, through ducts within the liner, and into the ice compartment vents.



**Ice Making/Harvest mode:** This mode looks for water valve or dispenser action within a 2-hour period of time (4-minute response time). If seen, the ice section temperature should be approximately 0°F degrees.

**Ice Storage mode:** If above activity is not detected, the temperature in the ice section could raise as high as approximately 15°-25°F.

**Ice Hardening mode:** This mode tries to account for high number of door openings and maintain similar temperatures as the ice storage mode.

Temperature in the ice section is tied to the control settings, so the warmer the freezer section is set, the warmer the ice section becomes. A freezer setting warmer than mid-range will produce the warmest ice section temperature.

**Note:** Ice stored for more than 10 days could clump.

## Ice Door

The ice door utilizes a plastic strike that engages a metal catch that is recessed in the door liner.



To access the door metal catch, it is necessary to pry out the catch trim using a small flat blade screwdriver.



*(Continued next page)*

The metal catch can be removed by lifting the 2 tabs out while pulling the catch from the door liner.

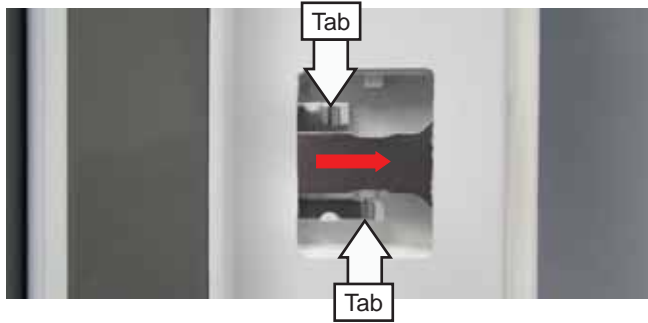

The ice door is attached to the left-side fresh food door with 2 hinges. Removing the 2 Phillips-head screws from the top hinge will allow the ice door to be lifted off the bottom hinge.



## Ice Compartment Vents

Both ice compartment vents utilize a gasket that seals to each liner duct vent when the left-side fresh food door is closed. It is necessary to pry out the gasket retainer to remove the gasket.

### Note:

- When installing the retainer, press the retainer in place with a slight twist counterclockwise.
- The liner duct vent is a non-replaceable part.



## Air Duct and Supply Duct Heaters

Air duct and supply duct heaters are connected in parallel and located inside the left-side fresh food door.

Air Duct and Supply Duct heaters will come on with abnormally high door-open time and high humidity. (Abnormal = approximately 70 fresh food door openings for 12 seconds or more in a 16-hour period.)

Applied voltage to this circuit can be tested at the main control board J8 to J7-9.

To replace the air duct and supply duct heaters, it is necessary to replace the left-side fresh food door.

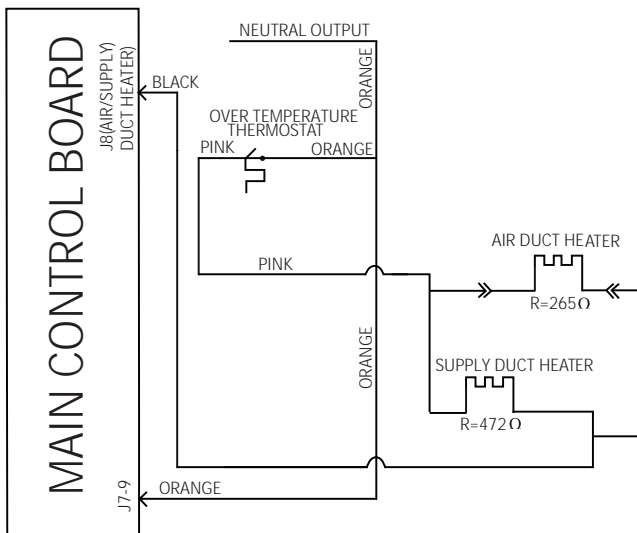

## Duct Port Heater

The duct port heater is located inside the left-side fresh food door around the ice compartment port holes.

The duct port heater cycles on temperatures and ice compartment conditions. (Mid-settings = heater on time approximately 30%)

Applied voltage to this circuit can be tested at the main control board J7-5 to J7-9.

To replace the duct port heater, it is necessary to replace the left-side fresh food door.

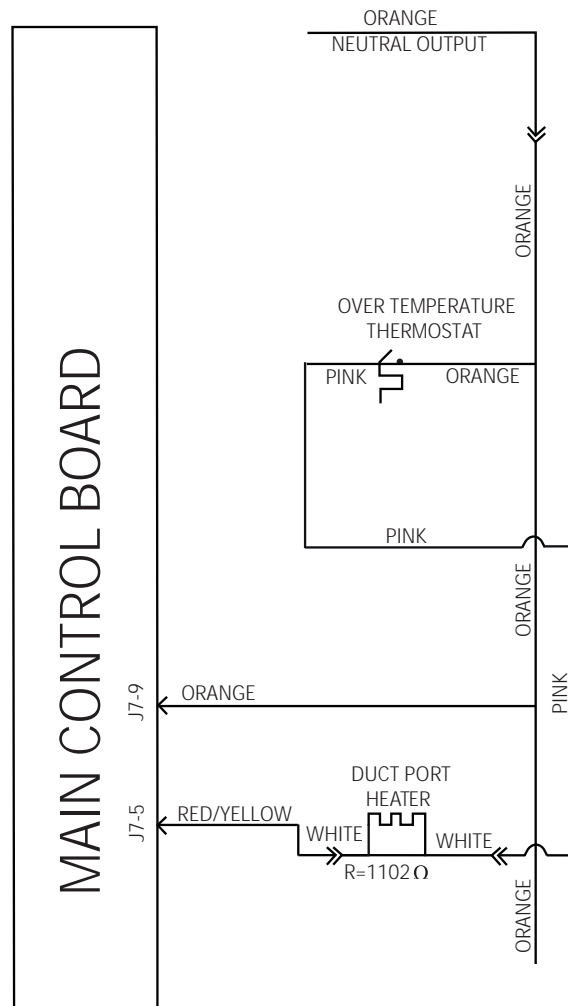

## Fill Tube Heater

The fill tube heater is located inside the left-side fresh food door.

The fill tube heater will be on after water valve activation or when ice is dispensed.

The heater is controlled by the main control board and will be on for 2 hours after water valve operation or when ice is dispensed.

Applied voltage to this circuit can be tested at the main control board J4-3 to J5-2.

To replace the fill tube heater, it is necessary to replace the left-side fresh food door.

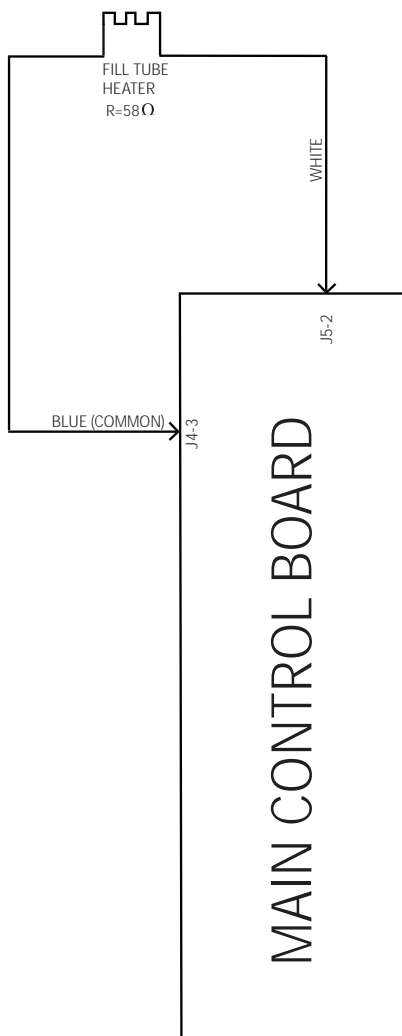

## Icemaker

To chill the icemaker, cold air enters the inlet port and exits the outlet port openings located on the right-side wall of the ice compartment.



The icemaker is attached to the back wall of the ice compartment with two 1/4-in. hex-head screws. The icemaker connects to a receptacle located on the auger motor housing.

**Note:** When replacing the IM use only the originally electronic IM part number.



Check for icemaker supply voltage of 120 VAC on the ice compartment wire harness receptacle brown to orange pins. (See *Auger Motor*, steps 2-3.)

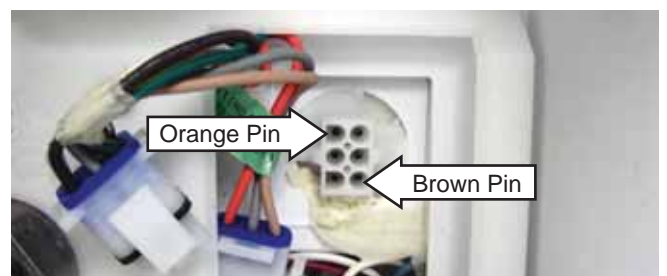

## Ice Bucket

The ice bucket is approximately 6 inches deep and 9 inches wide and holds approximately 4 lbs of ice.

The direction of the rotating blades determine if cubed or crushed ice exits the ice bucket. When viewed from the back, clockwise rotation allows the cutting side of the rotating blades to drive the cubes into the cutting side of the stationary blades to produce crushed ice. Counterclockwise rotation allows the back side of the rotating blades to lift and deliver ice cubes to the back side of the stationary blades, allowing cubes to exit the bucket.

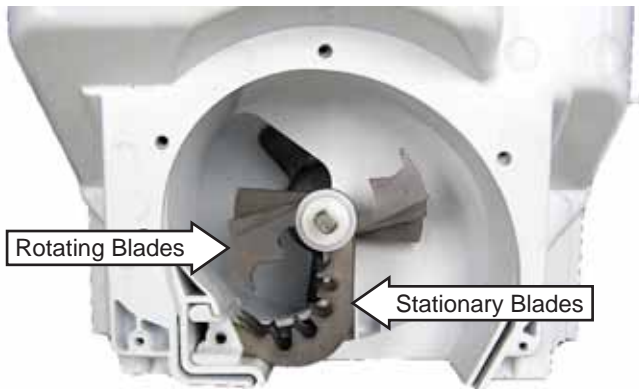

### To access the blades:

1. Remove the ice bucket from the door and place it front down on a protective surface.
2. Using a small flat blade screwdriver, pry the tabs on the lockwasher away from the hex nut.



**Note:** In the following step, it may be helpful to attach an adjustable wrench to the coupling.

3. Remove the 14-mm hex nut from the coupling.



4. Remove the 6 Phillips-head screws and the cover from the ice bucket.

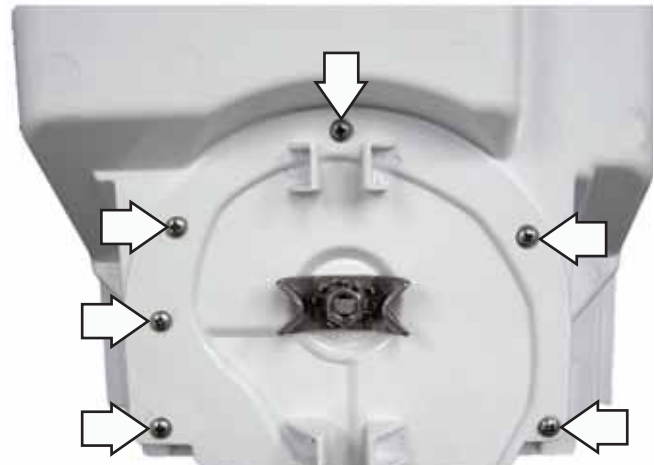

**Note:** Individual ice bucket parts are available and the ice bucket can be replaced as an assembly.

## Auger Motor

The auger utilizes a 120 VAC motor rated at 10.2 watts and draws .09 amps. The rated speed is 24.5 rpm. As viewed with the ice bucket out, clockwise rotation of the auger motor provides crushed ice, counterclockwise rotation produces cubes.

To remove the auger motor:

1. Remove the icemaker. (See *Icemaker*.)
2. Remove the 1/4-in. hex-head screw and the wiring access cover from the auger motor housing.



3. Disconnect the ice compartment wire harness.
4. Remove the three 1/4-in. hex-head screws from the auger motor housing.
5. Pull out the auger motor housing from the ice compartment.



6. Disconnect the auger motor wire harness.
7. Disconnect the 2 ground wires from the metal rear cover.
8. Remove the tape from the metal rear cover located at the back of the housing.

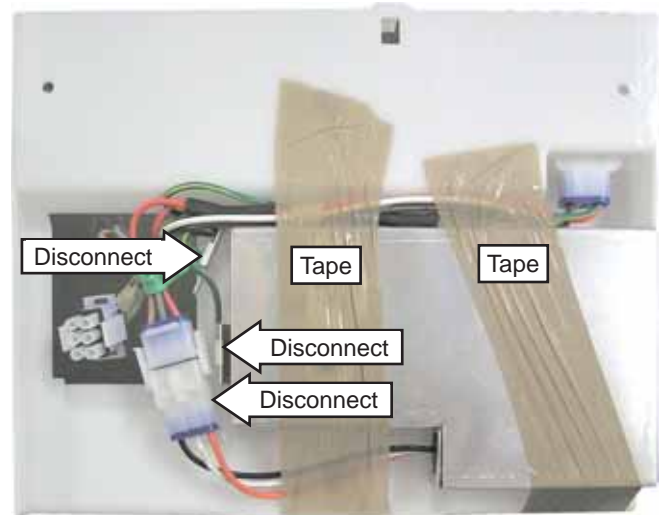

9. Using a small flat blade screwdriver, uncrimp the metal tabs located at the top right and bottom left corners of the metal rear cover. Remove the cover.

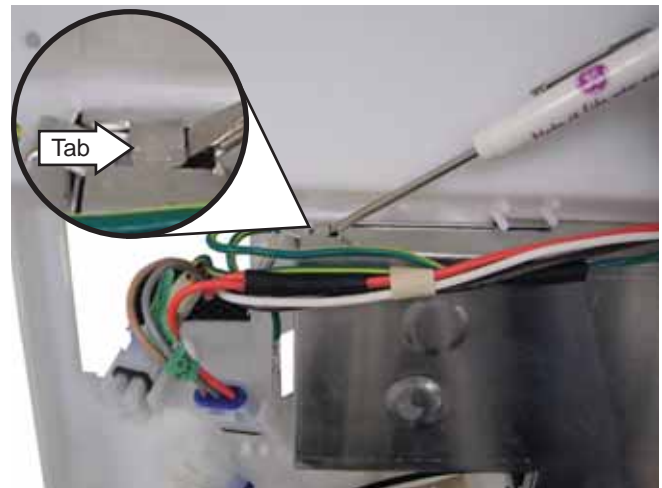

10. Remove the four T-10 Torx screws that attach the auger motor to the housing.

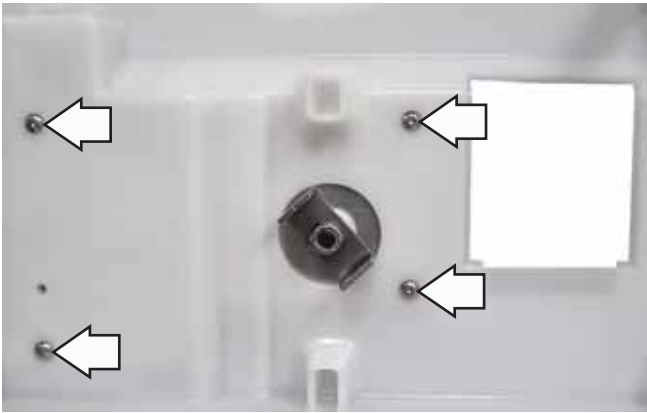

11. Remove the 1/2-in. hex-head nut, auger fork, and the metal front cover from the auger motor.

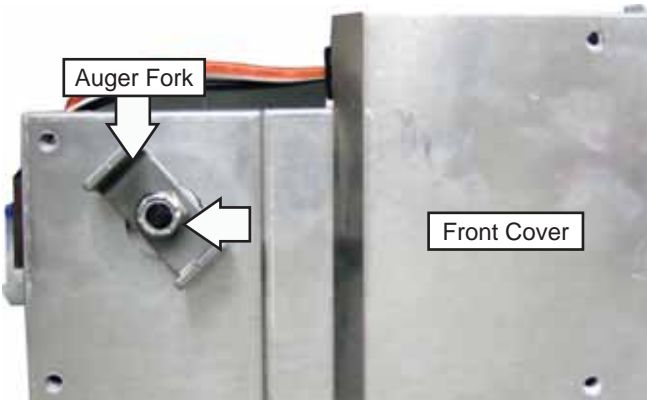

Check for auger motor supply voltage of 120 VAC on the disconnected auger motor wire harness.

Crushed rotation - orange (neutral) to beige wire

Cubed rotation - orange (neutral) to silver wire

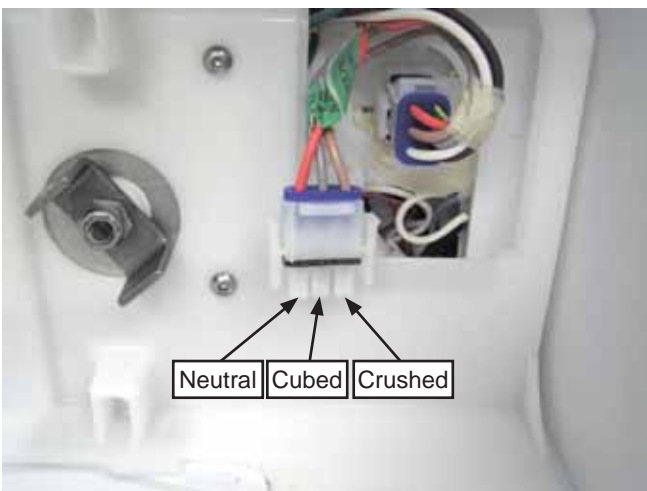

**Note:** To center the ice bucket cam and unload the crusher, the auger motor does a quick "reverse" action when dispensing is stopped (glass removed). (Not noticeable to consumer)

## Dispenser and Interface

The dispenser assembly incorporates the interface used for temperature control and features. The interface has 2 tabs that hold it to the dispenser housing. The tabs are located above 2 slots located behind the bottom of the interface.

To remove the water dispenser assembly:

1. Using a flat blade screwdriver, pry the bottom of the interface away from the dispenser recess.

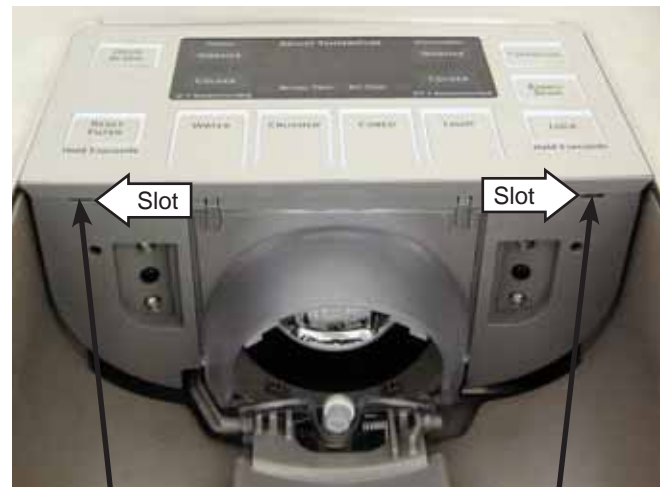

*(Continued next page)*

- Carefully lower the interface and disconnect the 3 wire harnesses.

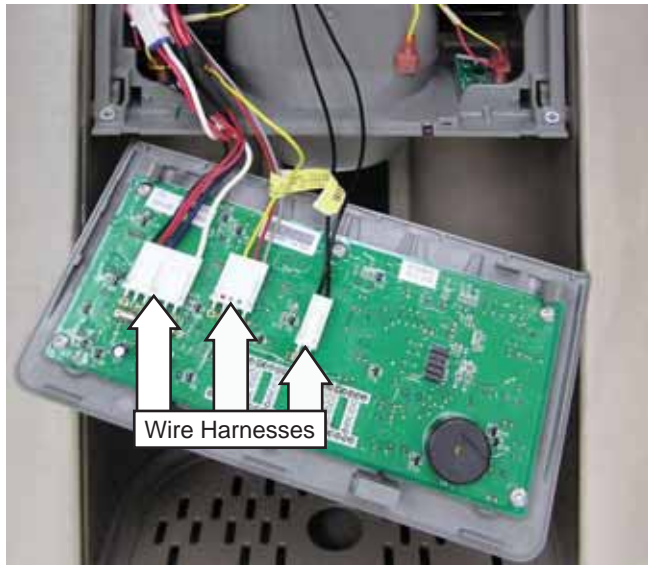

- Remove the 4 Phillips-head screws and the dispenser housing from the dispenser recess.



The dispenser cradle switch is attached to the left side of the dispenser housing with a Phillips-head screw.

Each of the 2 dispenser LED boards are attached to the dispenser housing with a plastic clinch rivet.

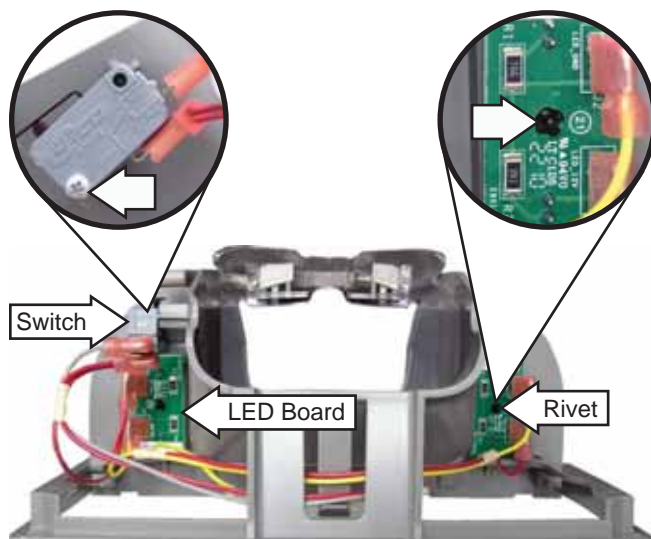

The duct door heater consists of the heater, door, and door seal, available as an assembly. The heater operates on 13.6 VDC and has an approximate resistance value of 109  $\Omega$ . The assembly is connected with a single wire harness and can be unsnapped from the solenoid-operated door crank.

The duct door heater is in a parallel circuit with the recess heater and the door gasket heater. These heaters operate based on temperature settings. For example, a freezer setting of mid-range temperature or higher equals 100 percent on-time except during ice dispense. Applied voltage to this circuit can be tested at dispenser board J4-2 to J4-6.

The solenoid operates on 13.6 VDC and has an approximate resistance value of 13  $\Omega$ . The solenoid is connected with a single wire harness and is attached to the recess with 3 Phillips-head screws.

Applied voltage to solenoid can be tested at dispenser board J1-1 to J1-2.

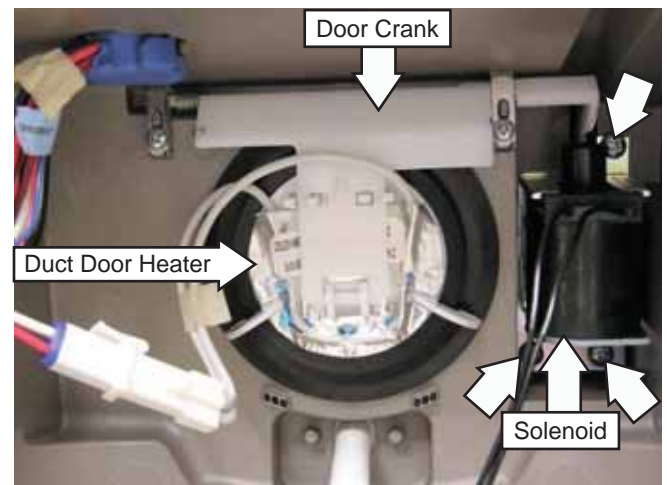
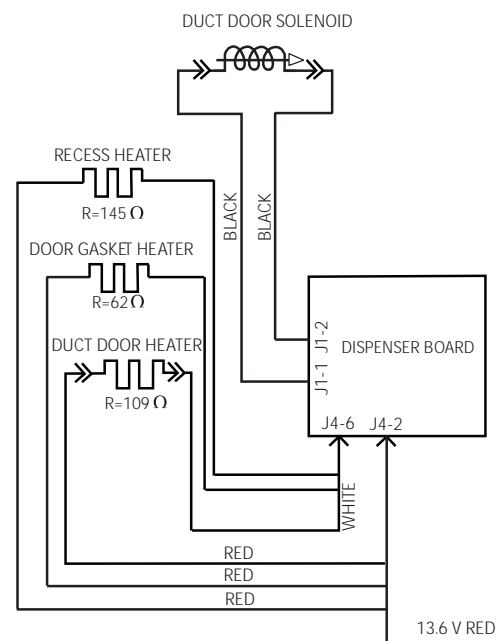

(Continued next page)

## Double Coil Water Tank

The double coil water tank is located in the bottom of the fresh food compartment. (See *Components Locator Views*.) The icemaker and dispenser water tank supply tubes, connected to the water valve, enter the fresh food compartment near the right side tank. Both tubes connect to exit tubing using John Guest couplings. Exit tubing located inside the liner connects to the disconnect collars located near the left-door bottom hinge and cannot be replaced.

### To remove the water tank:

1. Remove the fruit and vegetable crisper drawers and the crisper drawer cover and frame assembly.
2. Using a flat blade screwdriver, push the top black plastic lock clip (if utilized) off each coupling.
3. Carefully push the collar in while pulling each water line out from the coupling.
4. Remove the two 1/4-in. hex-head screws that attach each water coil.

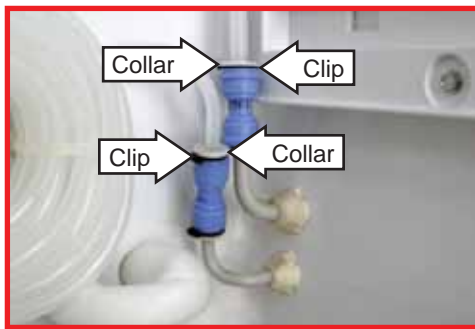

**Note:** In the following step, water may drain from disconnected tubing. Use care to avoid water spills.

5. Disconnect icemaker and water tank tubing from the water valve. (See *Water Valve*.)
6. Carefully pull water tank and tubing from the fresh food compartment.

## Fresh Food and Freezer Lights

### Fresh Food LED Lights

**Note:** Setting the controls to **OFF** does not remove power to the LED light circuit.

The fresh food section utilizes 9 LED light assemblies and the freezer utilizes 1 LED light assembly. All 9 fresh food LEDs are wired in parallel.

When a door or drawer is left open continuously for 10 minutes, the main control will turn off the lights. Once the door or drawer is closed and then opened, the 10-minute count starts over.

### Fresh Food LED Schematic

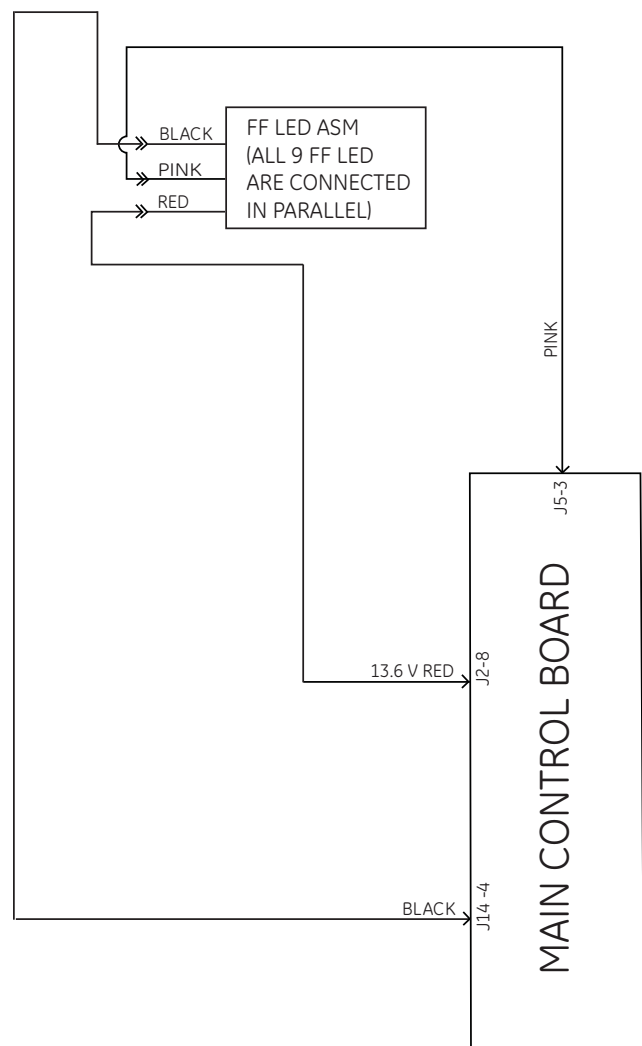

J14-4 = LED Ground

J2-8 = 13 VDC

J5-3 = LED Enable

**Note:** The fresh food and freezer LED light assemblies are removed in the same manner.

Each LED assembly consists of an LED board attached to the inside of a cover. To access the LED board, insert a flat blade screwdriver under the cover's notched end and gently pry out until it releases from the compartment wall. The LED board can then be unsnapped from the cover and the wire harness disconnected.

### Freezer LED



### Fresh Food LEDs

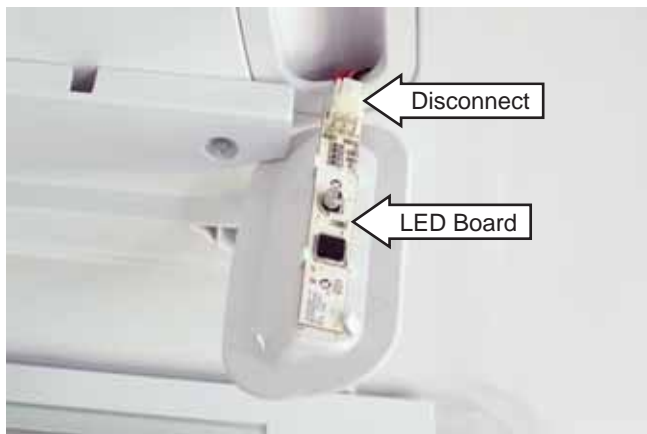
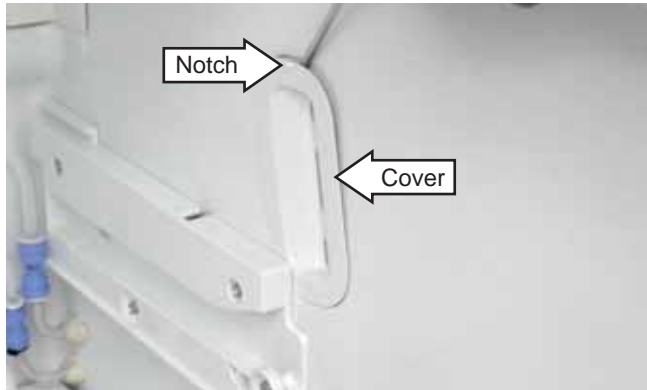

### Freezer LED Schematic

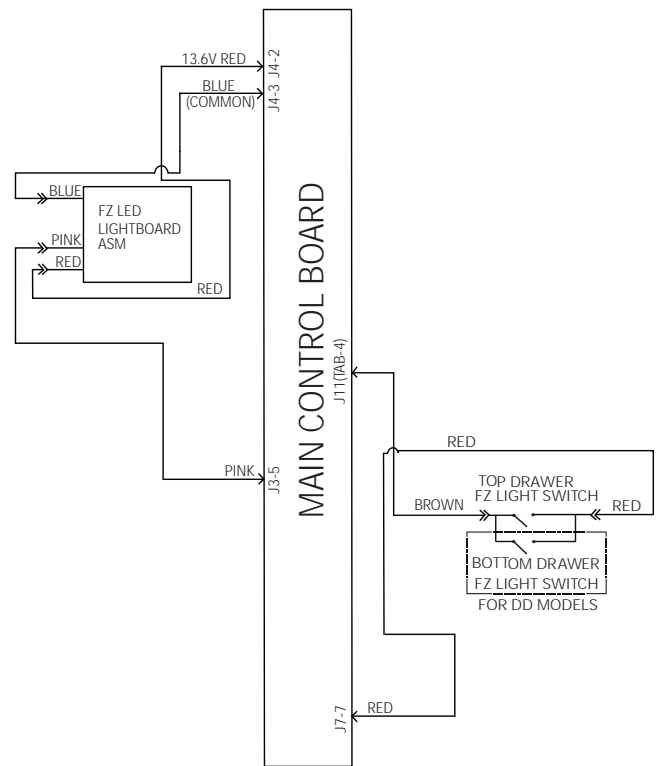

J4-3 = LED Ground

J4-2 = 13 VDC

J3-5 = LED Enable

## Thermistors

Thermistor Values		
Temperature Degrees (°F)	Temperature Degrees (°C)	Resistance in Kilo-ohms
-40	-40	166.8 kΩ
-31	-35	120.5 kΩ
-22	-30	88 kΩ
-13	-25	65 kΩ
-4	-20	48.4 kΩ
5	-15	36.4 kΩ
14	-10	27.6 kΩ
23	-5	21 kΩ
32	0	16.3 kΩ
41	5	12.7 kΩ
50	10	10 kΩ
59	15	7.8 kΩ
68	20	6.2 kΩ
77	25	5 kΩ
86	30	4 kΩ
95	35	3.2 kΩ
104	40	2.6 kΩ
113	45	2.2 kΩ
122	50	1.8 kΩ
131	55	1.5 kΩ
140	60	1.2 kΩ

**Note:** To accurately test a thermistor, place the thermistor in a glass of ice and water (approximately 33°F) for several minutes and check for approximately 16K Ω.

### Ambient Thermistor

The ambient thermistor is located under the freezer compartment and connected at J1-2 on the main control board. (See *Component Locator Views*.) It assists the main control board in compensating for room ambient that is higher or lower than 60°F.

For example, in ambient below 60°F, the fresh food temperature control will shut down properly. The cooler room ambient assists in keeping fresh food temperature at the preset temperature. However, the compressor does not get enough run time to bring the freezer down to 0°F.

At lower room temperatures, the ambient thermistor alters the main control board's calculations for the target temperature. The main control board then runs the compressor at higher speeds to get the freezer, as well as the fresh food, to an acceptable temperature.

If the external thermistor is not functioning, the main control board default will assume the ambient temperature is 90°F and there will be no adjustment to the fresh food or freezer set point.

The ambient thermistor is attached to the front of the base (under the left side of the freezer compartment) with a plastic wire tie.

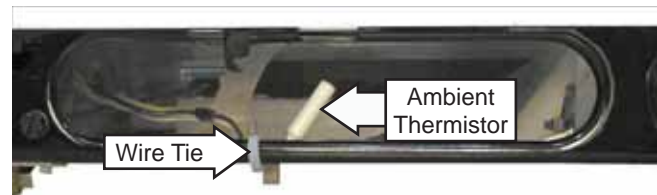

### Fresh Food and Freezer Thermistors

The fresh food thermistor is located in the left wall of the fresh food compartment and connected at J1-1 on the main control board. The freezer thermistor is located in the right wall of the freezer compartment and connected at J1-3 on the main control board.

**Note:** The fresh food and freezer thermistors are removed in the same manner.

To remove the thermistor cover, insert a flat blade screwdriver under the front of the cover and gently lift the bottom edge until it releases from the compartment wall.

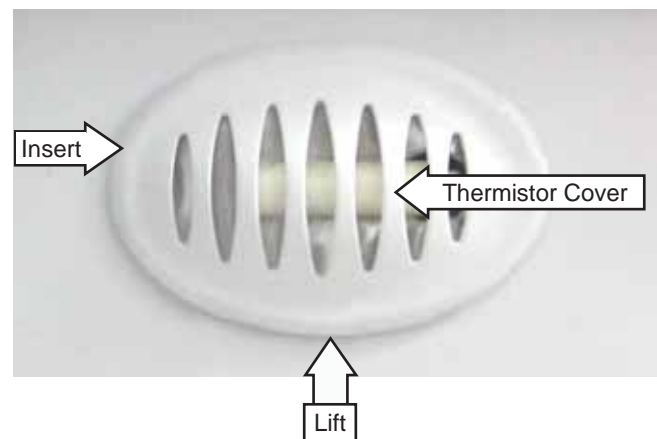

## Evaporator Thermistor

The evaporator thermistor is clipped to the suction tube line of the evaporator. (See *Evaporator* for accessing instructions.)



**Note:** When replacing the evaporator thermistor, splice a new thermistor into the harness using connectors and procedures approved for damp/wet conditions.

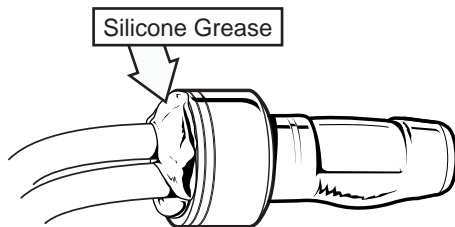

## Evaporator

The following components must be removed in the appropriate order to access the evaporator:

1. Unplug the refrigerator.
2. Remove the upper and lower freezer drawers. (See *Top Freezer Drawer*, *Bottom Freezer Drawer*.)

### Note:

- For added accessibility to freezer components, it may be necessary to remove the double drawers mullion assembly. (See *Double Drawer Mullion Assembly*.)
  - Each upper drawer side rail assembly is held in place by four 1/4-in. hex-head screws and a hook that locks into an opening in the side of the freezer.
3. Extend both upper drawer rail assemblies to the open position.
  4. Remove the four 1/4-in. hex-head screws that attach each upper rail assembly to the freezer wall.

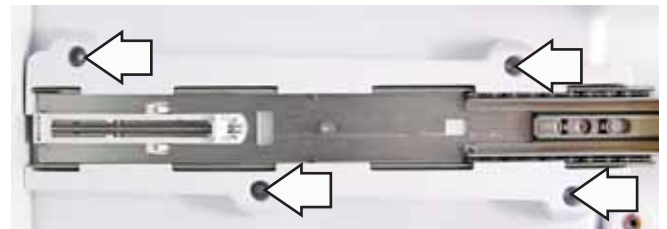

5. Pull the front of the rail assembly towards the center of the freezer and unhook the assembly from the side of the freezer.

6. Remove small black locating pin from the roller guide bar.

**Note:** For best results when re-installing the roller guide bar, start with rollers in rear location.

7. Slide the roller guide bar to right and remove it from the rollers.



8. Remove the five 1/4-in. Hex-head screws that attach each lower rail assembly to the freezer wall.

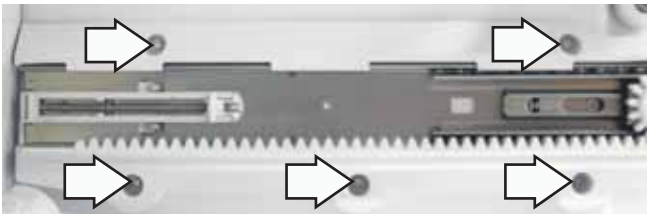

9. Pull the front of the rail assembly towards the center of the freezer and unhook the assembly from the side of the freezer.

10. Remove the 1/4-in. hex-head screw and the fan cover from the evaporator cover.



**Note:** The evaporator cover is attached to the evaporator compartment with 3 recessed 1/4-in. hex-head screws, 3 bottom tabs, and 5 snap tabs located on the back of the cover.

11. Remove the three 1/4-in. hex-head screws that attach the evaporator cover.

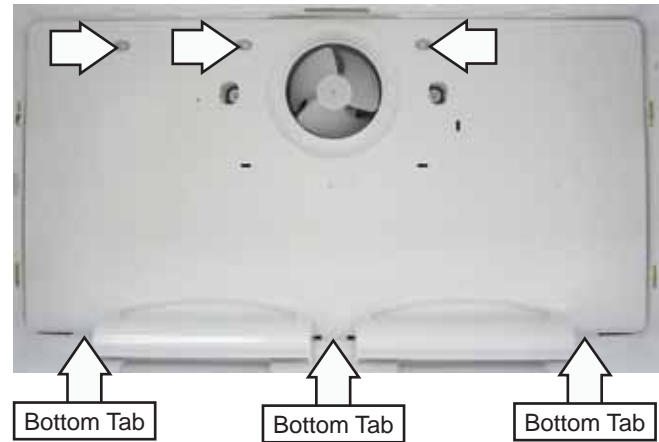

12. Grasp the right side of the fan opening and pull the cover towards the front of the freezer to release the right side snap tabs.

13. Reach in and disconnect the evaporator fan motor wire harness, and then remove the cover from the freezer.

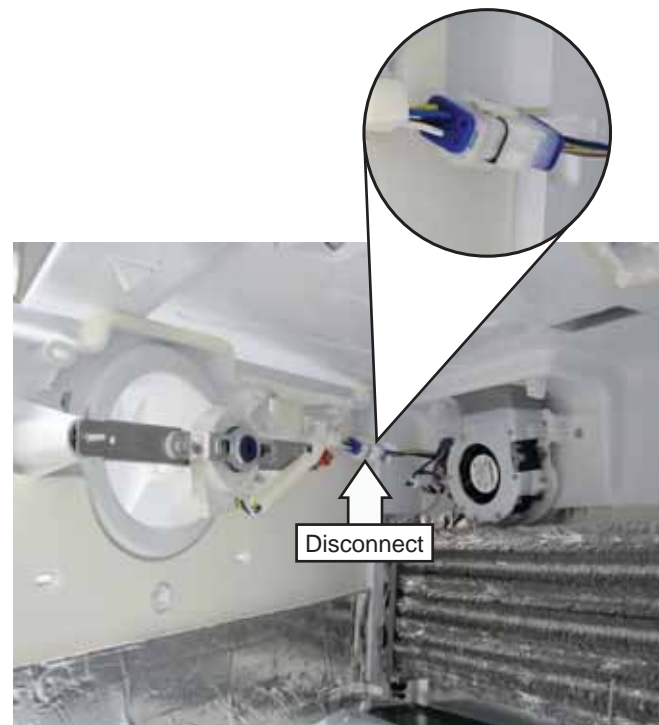

## Evaporator Fan

The position of the fan blade in relation to the shroud is important.

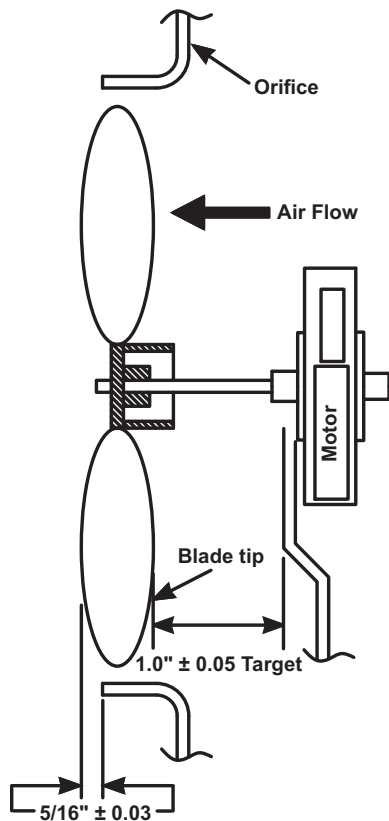

The evaporator fan is the same fan used on previous models; however, a significant difference is that the main control board neither requires nor receives input from the fan feedback/rpm (blue) wire. The fan utilizes a permanent magnet, 4-pole, DC motor that operates at 3 different speeds: high, medium, and low.

Supply voltage from the main control board (J2-8 to J2-3) remains at a constant 13.6 VDC.

The speed of the fan is controlled by the signal voltage output from the main control board (J2-4 to J2-3). Voltage output from the main control board to the fan is 13.6 VDC; however, to regulate the speed of the fan, the main control board uses pulse width modulation (PWM).

When operating, voltage is sent in pulses (much like a duty cycle) as opposed to an uninterrupted flow. This pulsing of 13.6 VDC produces effective voltage being received at the motor, that is equivalent to a reduction in voltage.

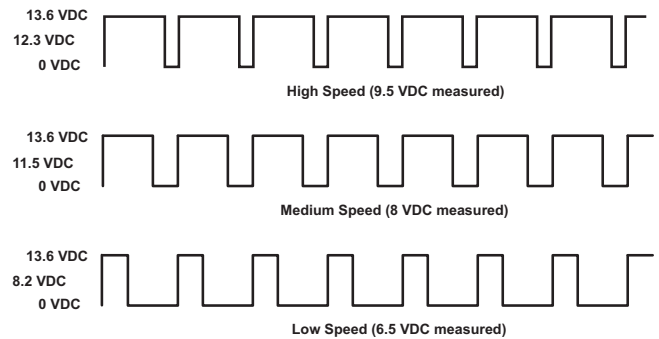

**Note:** Depending on speed, the effective voltage may range from 6.5 - 13.6 VDC.

Fan speed is selected and maintained by the main control board regulating the length and frequency of the 13.6 VDC pulse. Temperature can cause some fan speed variation. Fan speed can vary +/- 5%, depending on the temperature, with higher temperatures causing slightly higher speeds.

The evaporator fan has a 4-wire connection:

### White Wire - DC Common (J2 pin 3)

The white wire is the DC common wire used for testing. During repairs, DC polarity must be observed. Reversing the DC polarity causes a shorted motor and/or board.

### Red Wire - Supply (J2 pin 8)

Each motor uses an internal electronic controller to operate the motor. Supply voltage from the main control board remains at a constant 13.6 VDC.

### Blue Wire - Feedback/RPM (J2 pin 1)

On previous Arctica models, the blue wire reported rpm (speed) information to the main control board for speed control purposes. On this model, the board does not require or read any feedback information from the fan motor.

### Yellow Wire - Signal (J2 pin 4)

The yellow wire is the input wire from the main control board. The main control board provides 8.2 VDC effective voltage for low speed, 11.5 VDC effective voltage for medium speed, and 12.3 VDC effective voltage for high speed. The fan operates in low speed only when the fresh food thermistor is satisfied.

*(Continued next page)*

**Note:** When testing these motors:

- You cannot test with an ohmmeter.
- DC common is not AC common.
- Verify 2 voltage potentials:
  - a. Red to white - power for internal controller
  - b. Yellow to white - power for fan
- Observe circuit polarity.
- Motors can be run for short periods using a 9-volt battery. Connect the white wire to the negative (-) battery terminal only. Connect the red and yellow wires to the positive (+) battery terminal.

The evaporator fan motor is positioned between the front and rear fan motor brackets that are attached to the back of the evaporator cover. The evaporator cover must be removed to access the fan motor brackets. (See *Evaporator*.)

Note the position of the fan blade on the motor shaft and the locations of the fan motor mounting grommets.

To remove the fan motor, it is necessary to pull the fan blade off the motor shaft and remove the two 1/4-in. hex-head screws that hold the rear bracket to the front bracket. A single wire harness is connected to the fan motor.

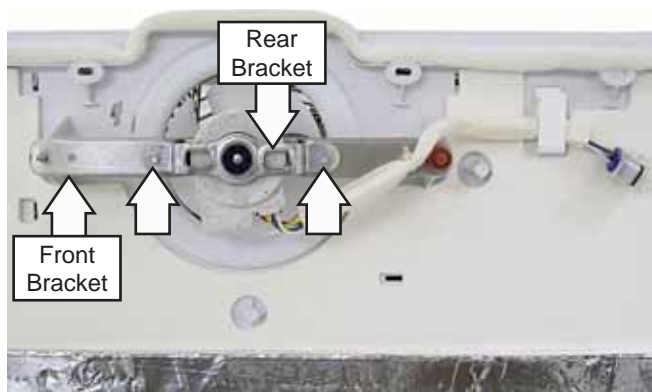

**Note:** To prevent excessive vibration and noise, be sure to install the fan motor grommets in their original positions.

## Ice Compartment Fan

The ice compartment fan utilizes a 12 VDC motor that is capable of circulating 10 CFM of freezer air through the ice compartment. The fan is located above the evaporator and attached to the back wall of the freezer with two 1/4-in. hex-head screws. A single wire harness is connected to the fan motor. The evaporator cover must be removed to access the ice compartment fan. (See *Evaporator*.)

### Ice Compartment Fan – Basic Operating Modes

The new Profile Bottom Mount Ice and Water Refrigerators have multiple basic modes of operation:

- Ice fan duty cycle's are 100% or 50% based on temperature settings. (Twenty minutes on/off time during 50% duty cycle.)
- Ice Hardening mode: Fan on high speed, while compressor is on.
- Ice Storage mode: Fan on low speed, while compressor is on.
- Fan speed and on-time are calculated with a multitude of algorithms.
- Changes to the time and speed can vary.
- Changing the freezer temperature settings will prompt new calculations.
- Ice fan is off when the compressor is off and during all phases of defrost. (Defrost, Dwell & Post-dwell)

### Abnormal Modes

- When the unit is in liner protection mode, the ice compartment fan will run in low speed (along with the evaporator fan in low speed).
- If the fresh food damper has been open for 2 hours continuously and the unit is in ice storage mode, the ice compartment fan will turn on at low speed and run until the damper closes.

Check for 12 VDC on main control board locations J2-7 to J2-8.

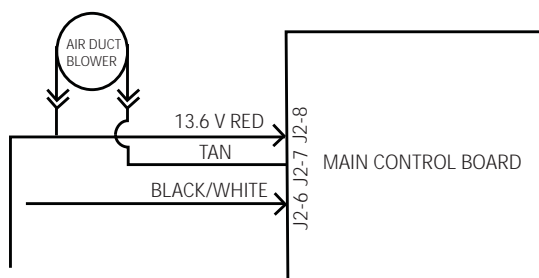

(Continued next page)

## To remove the ice compartment fan:

1. Remove the evaporator cover. (See *Evaporator*.)

**Note:** In the following step, it may be helpful to remove the Phillips-head screw and the wire tie from the fan harness connection.

2. Disconnect the fan wire harness.
3. Remove the two 1/4-in. hex-head screws and the fan from the freezer back wall.

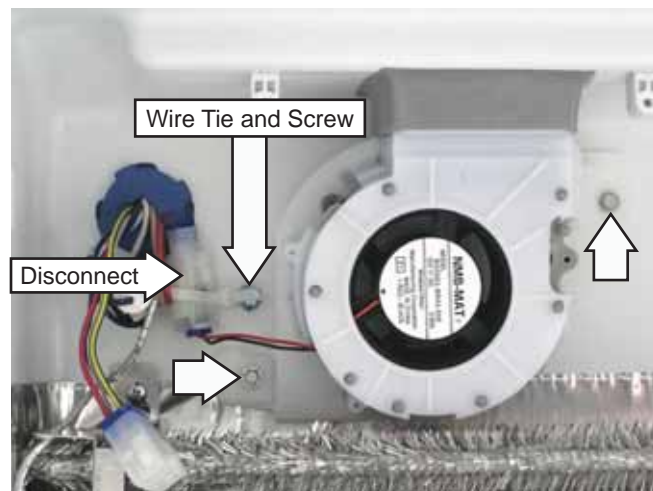

**Note:** The ice fan comes as an assembly. The rubber boot is available as a separate part.



## Defrost Heater

The defrost heater is a single-tube, glass-enclosed radiant heater. It is held in place by 2 tabs on the evaporator (1 on each side) and by a ceramic and wire support. The defrost heater has an approximate resistance value of 31.5  $\Omega$ .

### To remove the defrost heater:

1. Access the freezer evaporator. (See *Evaporator*.)

#### Note:

- During defrost, the drain probe assists in preventing the drain from icing closed. During assembly, the probe must be installed on the evaporator and inserted in the drain to prevent drain freeze-up.
  - A ceramic and wire support prevents the heater from sagging and touching the metal drain trough if the glass is broken.
2. Remove the ceramic and wire support and the drain probe from the evaporator.

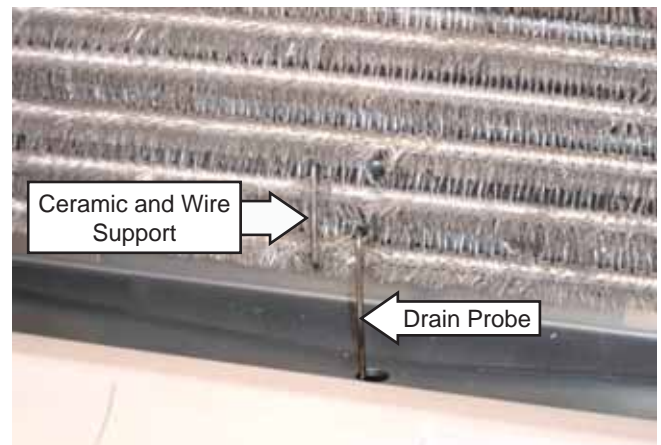

3. Bend the aluminum tabs back (located at each end of the defrost heater) and lower the heater out of the evaporator.
4. Disconnect 2 lead wires and remove the heater.

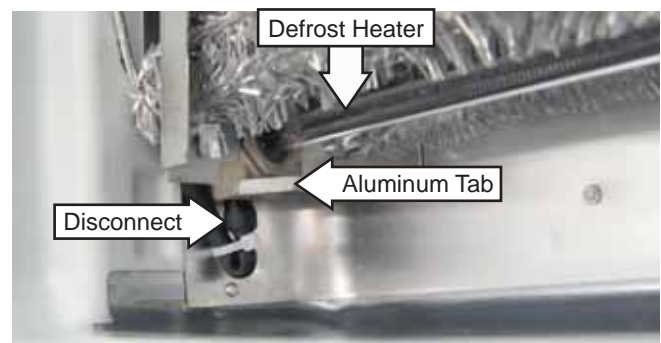

## Over-Temperature Thermostat

The over-temperature thermostat is in a series circuit with the defrost heater and return duct heaters. Once the temperature of the thermostat reaches 140°F, the thermostat cycles the defrost heater and the return heaters off.

Remove the evaporator cover to access the over-temperature thermostat. (See *Evaporator*.) The thermostat is clipped onto the suction line.

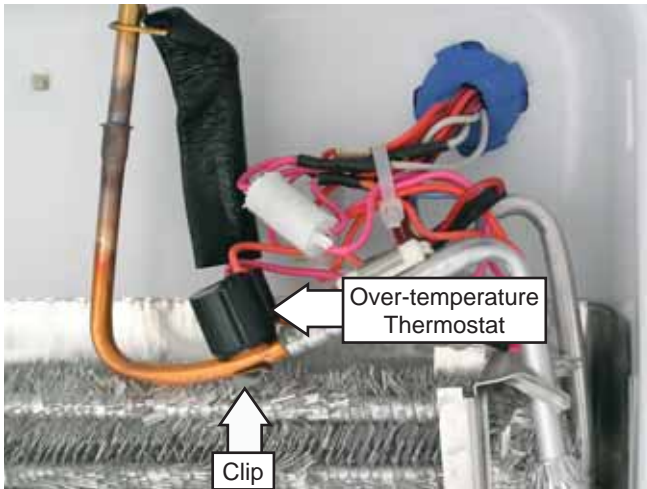

**Note:** When replacing the over-temperature thermostat, splice a new thermostat into the wiring using connectors and procedures approved for damp/wet conditions.

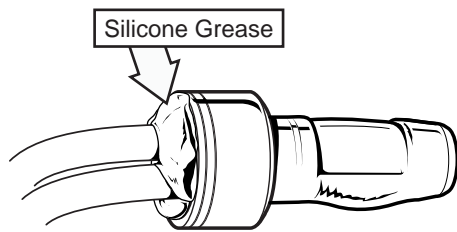

## Return Duct Heaters

A return duct heater has been added to each of the 2 fresh food compartment return air ducts. The heaters prevent water from freezing and blocking the air flow in the ducts. Restricted ducts can cause warm fresh food temperatures. (See *Airflow*.)

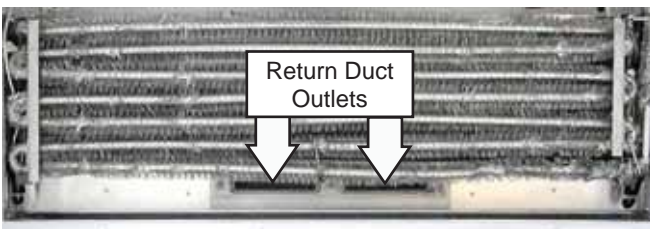

The heaters operate with 120 VAC and each heater has an approximate resistance value of 440  $\Omega$ . The heaters are in a parallel circuit consisting of 2 duct heaters and the defrost heater. The line voltage wires of the duct heaters are connected to the blue wire of the defrost heater. The neutral wires of the heaters go through the over-temperature thermostat. The 2 duct heaters are energized (along with the defrost heater) during the defrost cycle when the over-temperature thermostat is closed.

## Return Duct Heaters Test

If open duct heaters are suspected, perform the following:

1. With the over-temperature thermostat closed, test for approximately 30  $\Omega$  (the equivalent resistance of this parallel circuit) between J9 and J7-9.
2. For a resistance reading other than approximately 30  $\Omega$ , remove the evaporator cover. (See *Evaporator*.) Remove the Phillips-head screw and the mullion wire harness cover from the freezer left-side wall. Disconnect the left-side wire (blue wire) from the defrost heater. Insert a volt ohmmeter into the disconnected defrost heater wire. Insert the other lead into the orange wire connection of the mullion heater. A reading of approximately 220  $\Omega$  indicates both heaters are good.

**Note:** The return duct heaters are integral to the foamed-in-place internal ductwork of the refrigerator and are not replaceable.

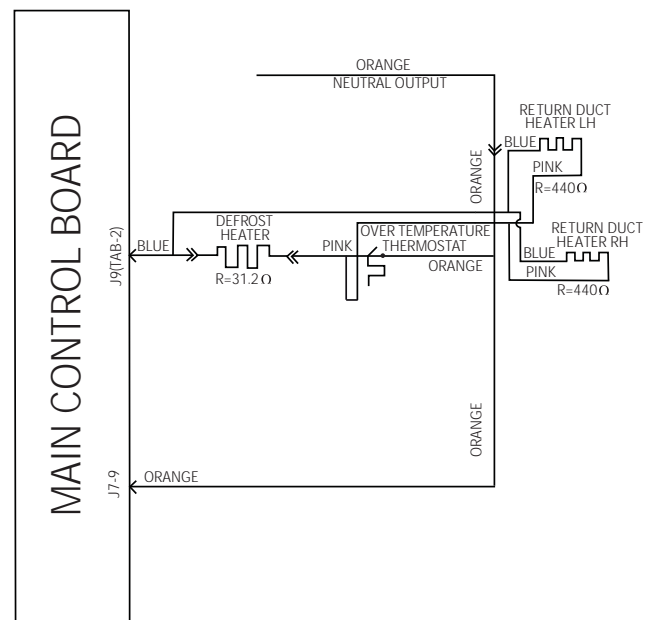

## Replacing Evaporator Using Brazing Method

### Parts Needed:

- Freezer Evaporator
- Drier Assembly
- Access Tube (part # WJ56X61)
- Heat Shield Kit (part # WX5X8926)

**Caution:** A heat shield kit is required for this procedure to prevent damage to the plastic interior (liner) of the freezer compartment.

**Note:** If it is determined that the epoxy joints (the transition joint between the aluminum and copper jumper) on the freezer evaporator assembly are defective, then LOKRING connectors can be used to repair the joints. Refer to Service Guide #31-9067 for complete instructions on using the LOKRING method of installing an evaporator.

1. Unplug the refrigerator.
2. Remove the rear access cover and evacuate the sealed system.
3. Remove components necessary to expose the evaporator. (See *Evaporator*.)
4. Note the location of the thermistor and over-temperature thermostat on top of the old evaporator and remove.
5. Remove heater from bottom of evaporator. Bundle remaining wires and tape high on the back wall of freezer.
6. Apply a liberal amount of thermal paste to suction line where it enters the rear wall of freezer.
7. Insert the brazing shield behind the joints of the evaporator inlet and outlet to protect the liner.
8. Use torch to heat the joints of the evaporator inlet and outlet, separate the joints and clean the suction line and the capillary surface.
9. Loosen the 2 Phillips-head screws that hold the evaporator in place. Note locations of the heat transfer wires at the sides of old evaporator. These are needed to transfer heat to the turns of the evaporator during the defrost cycle. Remove the transfer wires and save for new evaporator installation. Remove the old evaporator.
10. Install the new evaporator and tighten the 2 Phillips-head screws.

11. Connect the evaporator inlet and outlet to the suction line and capillary tubes.
12. Check that the thermal paste is still on the suction line where it enters the rear wall of the freezer. If not, apply paste. In addition, apply thermal paste around epoxy joints on the new evaporator to prevent the heat from damaging joint integrity.
13. Move the brazing shield behind the capillary and suction line joints. Protect the freezer floor from molten solder during brazing.
14. Angle torch so that flame is directed away from rear wall when brazing. Braze suction line and capillary to new evaporator.
15. Remove the brazing shield. Clean and inspect all joints.
16. Remove the old drier by cutting the halo loop as close as possible to the drier. Install the new drier assembly making sure that there is sufficient space between the tubing.
17. Install the access tube. Clean and inspect joints.
18. Replace the heater supplied with the evaporator. Reinstall the over-temperature thermostat, thermistor, and heat transfer wires at the sides of new evaporator. Dress wiring.
19. Evacuate and charge the system. Use original factory charge quantity of R-134a. (See *Evacuation and Charging Procedure*.)
20. Replace all component parts in the freezer.
21. Reinstall the rear access cover.

## Replacing Evaporator Using LOKRING Method

### Parts Needed:

- Freezer Evaporator
- Drier Assembly
- Access Tube (part # WJ56X61)
- LOKRING Connectors (part # WR97X10044)

**Note:** If it is determined that the epoxy joints (the transition joint between the aluminum and copper jumper) on the freezer evaporator assembly are defective, then LOKRING connectors can be used to repair the joints. Refer to Service Guide #31-9067 for complete instructions on using the LOKRING method of installing an evaporator.

## Evacuation and Charging Procedure

### WARNING:

- Be careful when using a torch inside the plastic cabinet. Use approved safety equipment and protect the liner from damage with the heat shield kit (part #WX5X8926) that includes the heat shield and thermal paste. The thermal paste is available separately (part #WX5X8927).
  - Before cutting or using a torch on refrigerant tubes, recover the refrigerant from the system using approved recovery equipment.
  - Never charge new refrigerant through the purge valve. This valve is always located on the high-pressure side of the system.
  - Never apply heat from any source to a container of refrigerant. Such action will cause excessive pressure in the container.
  - Always wear goggles when working with refrigerants and nitrogen holding charge in some replacement parts. Contact with these gases may cause injury.
1. Attach the hose from the R-134a charging cylinder to the process tube port on the compressor.
  2. Evacuate the system to a minimum 20-in. vacuum using the refrigerator compressor and recovery pump that is attached to the new drier assembly.
  3. Turn off the recovery pump. Close the ball valve on the hose connected to the high-pressure side port connection. Add 3 ounces of R-134a refrigerant to the system. Let the refrigerator operate and circulate the refrigerant for 5 minutes.
  4. Open the ball valve. Recover the purge/sweep charge using the recovery pump and the refrigerator compressor until a 20-in. vacuum is attained. Close the ball valve and remove the recovery hose.
  5. Charge the system with the exact amount of R-134a refrigerant specified.
  6. Disconnect the power cord to the refrigerator. This allows the pressure to equalize. After 3 to 5 minutes, the low-pressure side will be positive. Once it is positive, the hose-to-charging port can be disconnected.
  7. Using an electronic leak detector, check all brazed joints and both Schrader ports. Reinstall caps to Schrader ports.

## Fresh Food Damper

A damper assembly is used to control airflow from the freezer into the fresh food compartment. It is located on the back wall of the fresh food compartment, behind the deli and crisper drawers. The damper assembly consists of a 12 VDC motorized damper (sealed inside a styrofoam air tower), inlet gasket, and a plastic air tower cover. The assembly is held in place with one 1/4-in. hex-head screw at the top, and 2 pins at the bottom that fit into the liner.

### To remove the fresh food damper:

1. Remove the fruit and vegetable crisper drawers and the crisper drawer cover and frame assembly.

**Caution:** The glass inserted in the deli pan cover and frame may easily separate. Care should be taken when removing the deli pan cover and frame assembly.

2. Partially open the deli pan, lift and remove the deli pan cover and frame.

**Note:** For added accessibility to the fresh food damper, it may be helpful to remove the deli pan drawer. (See *Deli Pan Removal*.)

3. Pull the deli pan out to the fully open position.
4. Remove the 1/4-in. hex-head screw from the top of the air tower cover.

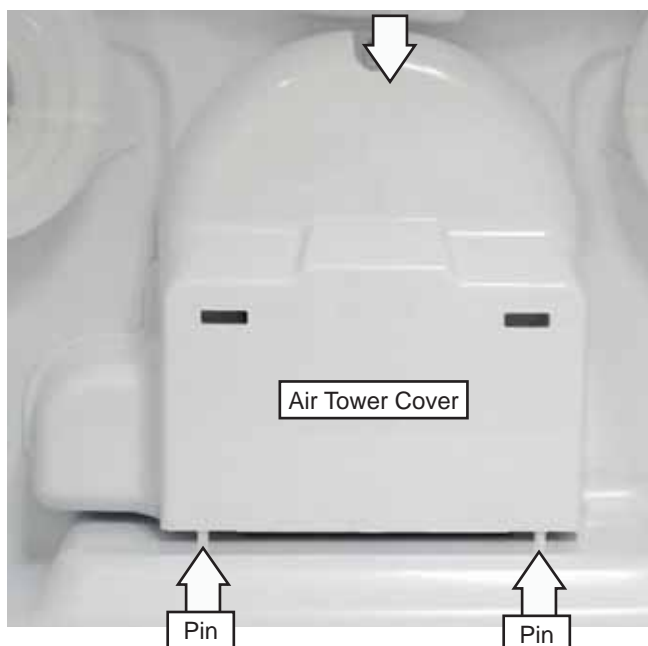

5. Pull up on the damper assembly until the pins are out of the holes in the liner, and then tilt it toward the front of the refrigerator.



6. Disconnect the damper motor wire harness.

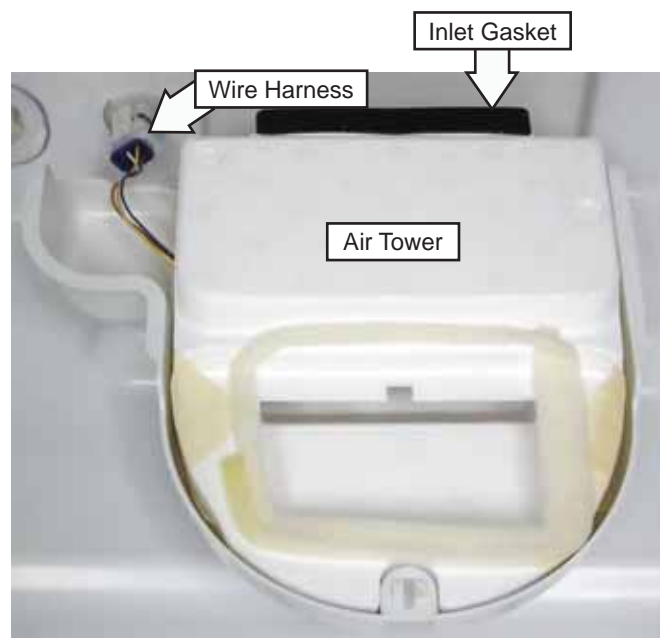

### Note:

- The damper assembly (part # WR17X12456) includes the motorized damper, inlet gasket, air tower, and the air tower cover.
- To prevent moisture and ice from accumulating in the fresh food compartment, ensure the inlet gasket is seated correctly between the bottom of the air tower and the liner.

## Humidity Sensor

This device senses the humidity in the kitchen and assists the control board in adjusting the wattage outputs of the 3 mullion heaters accordingly.

The humidity sensor receives a constant 5 VDC from the main control board (J4-3 to J5-5) and sends back 1 to 3.6 VDC (J4-3 to J5-6), depending on the relative humidity. The higher the humidity, the higher the output voltage. Any output higher than 4 VDC or lower than 1 VDC indicates the sensor has failed.

F.I. (Field Inspector) Testing – A reading of approximately 0-100 would be considered normal. A reading of 150 or higher indicates a failed humidity sensor.

There is no resistance check for the humidity sensor. A failed sensor could keep the mullion heaters on for longer periods.

The humidity sensor is contained in a housing that is attached to the front of the base with a Phillips-head screw.

To access the humidity sensor, it is necessary to remove the 2 Phillips-head screws and the base grille from the refrigerator.

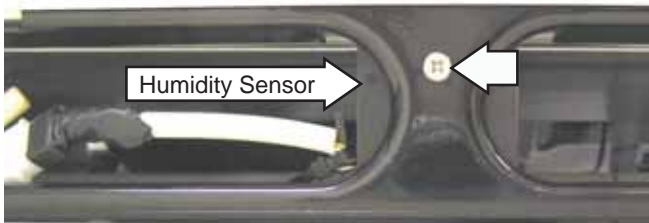

Humidity Sensor-Front View



Humidity Sensor-Rear View

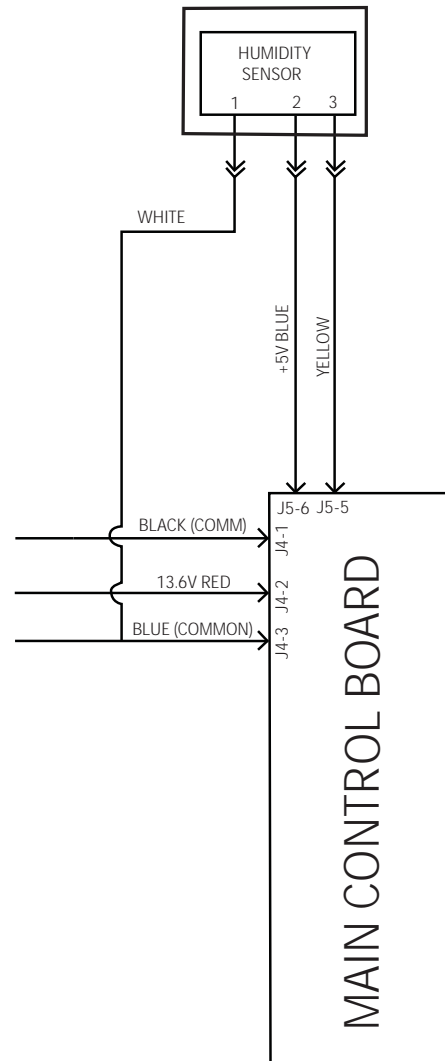

## Mullion Heaters

The refrigerator utilizes 2 AC mullion heaters and 1 DC mullion heater. They are the articulating door mullion (DC), fresh food/freezer mullion (AC), and double drawer mullion heaters (AC).

The 3 mullion heaters are controlled by the main board software logic. The main control board takes into account the percentage of room humidity, room temperature, and either freezer or fresh food temperatures. As the room humidity increases, the amount of voltage supplied to the heaters is increased to keep the mullion surfaces from sweating. At lowest humidity, the articulating door mullion and fresh food/freezer mullion may turn off completely, but the double drawer mullion heater will always have some voltage present.

If the control panel is not equipped with an energy saver pad, the heaters are controlled automatically by the board based on thermistor and humidity sensor input.

If the energy saver selection (if available) is off, all heaters are on.

When the energy saver selection (if available) is on, the articulating door mullion and the fresh food/freezer mullion are off. The double drawer mullion heater is on at a lower rate.

The double drawer mullion heater will not operate with either freezer drawer in the open position.

Every 20 minutes, the main control board utilizes a duty cycle to monitor and react to the condition of the humidity sensor. Control board corrections, if needed, are made at a specific time period during the duty cycle.

If the control detects a failed humidity sensor, and the energy saver (if available) is off, all mullion heaters will be operated at 100%.

If the control detects a failed humidity sensor, and the energy saver (if available) is on, the double drawer mullion heater will be operated and cycle at a rate of 21% on time and 79% off time. The articulating door and fresh food/freezer mullion heaters will remain off.

The double door and horizontal mullion heaters are off during ice dispense to reduce power supply output. They remain off for 5 more seconds after ice dispense completed.

Sweat or frost on mullion surfaces indicate malfunctioning heaters, wiring, or control board.

The double door and horizontal mullion heaters can only operate when the over-temperature thermostat contacts are closed.

Applied voltage to the double door and horizontal mullion heaters can be tested at main control board J7-9 to J12.

The horizontal mullion heater is not replaceable. The double drawer mullion heater can be replaced as a separate part. (See *Double Drawer Mullion Assembly*.)

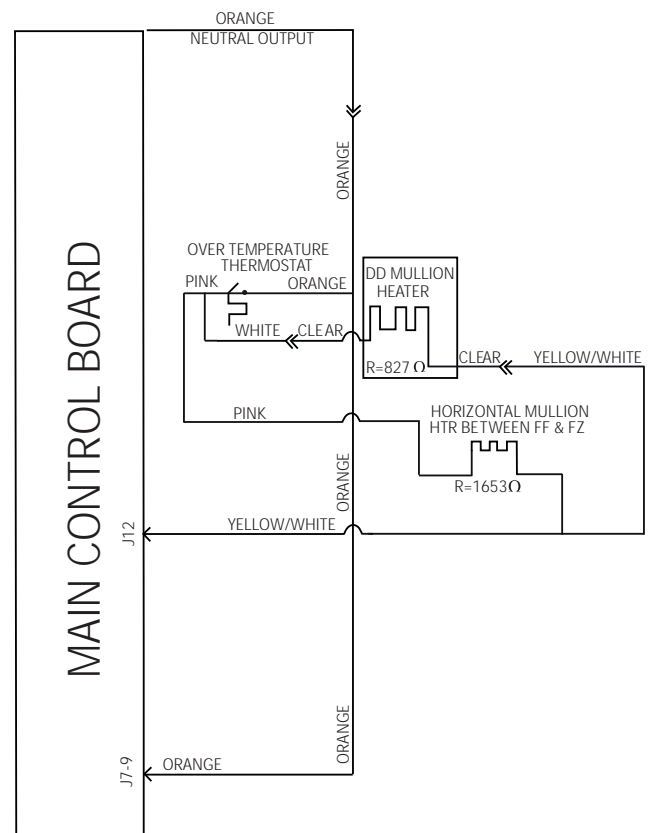

Applied voltage to the articulating door mullion heater can be tested at the main control board J2-6 to J2-8.

The articulating door mullion heater can be replaced as a separate part. (See *Articulating Door Mullion*.)

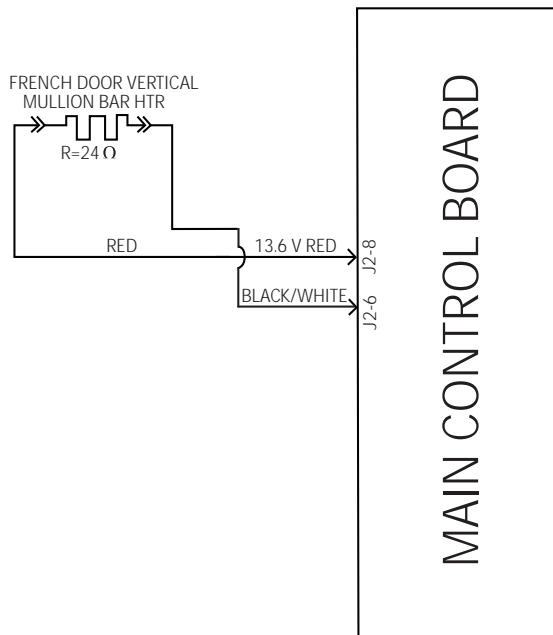

## Articulating Door Mullion

The articulating door mullion consists of the mullion, heater, internal spring, and 2 hinges. It is available only as an assembly.

The articulating door mullion is attached to the left side door, and provides a movable center mullion that maximizes access to the fresh food compartment. With both refrigerator doors closed or only the right side door opened, the mullion stays in position. When the left side door is opened, the spring-loaded mullion is activated to fold against the handle side of the door liner.

The pin on top of the mullion and the track, located at the top center front of the refrigerator, ensures proper mullion bar alignment upon closure of the left side door.

Door Closed -  
Pin in Track

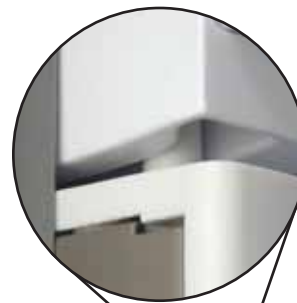

Door Opening -  
Pin Exiting Track



**Note:** If the Energy Saver light (if available) is on, then the articulating door mullion heater is disabled.

The heater operates on DC voltage when both doors are closed. It is necessary to close the right side door and close the left side light switch to test for the operating voltage of 0 to 13.6 VDC. (See *Mullion Heaters*.) The resistance of the heater is approximately 24  $\Omega$ .

To replace the articulating door mullion assembly, remove the 2 Phillips-head screws from the top and bottom hinges. The wire harness can be pulled out from the recess in the bottom of the door and disconnected.

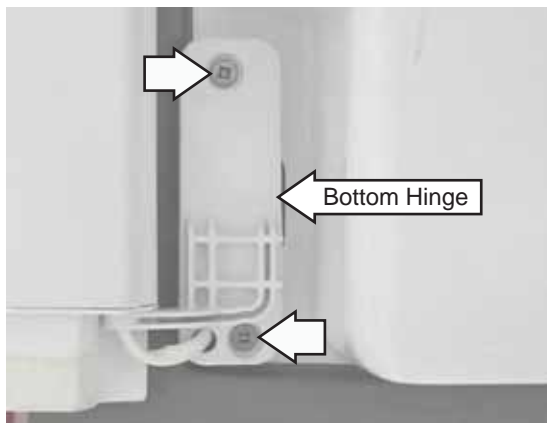
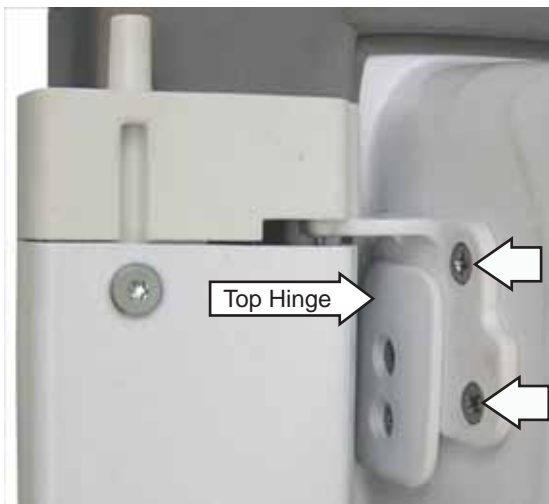

## Double Drawer Mullion Assembly

The double drawer mullion assembly consists of a mullion heater bonded to a mullion face. The mullion face is attached to the mullion with 4 Phillips-head screws. The mullion is inserted in 2 recesses and attached to the freezer walls with four 3/16-in. Allen-head shoulder bolts.

**To remove the double drawer mullion assembly:**

1. Unplug the refrigerator.
2. Remove the top and bottom freezer drawers. (See *Top Freezer Drawer*, *Bottom Freezer Drawer*.)
3. Remove the 4 Phillips-head screws that attach the mullion face to the mullion.



4. Separate the mullion face from the refrigerator cabinet.
5. Disconnect the mullion face wire harness and ground wire.

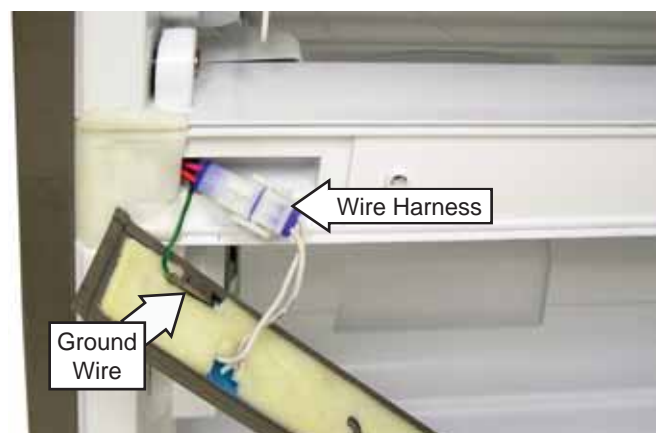

- Remove the four 3/16-in. Allen-head shoulder bolts (2 on each side) that attach the mullion to the freezer walls.

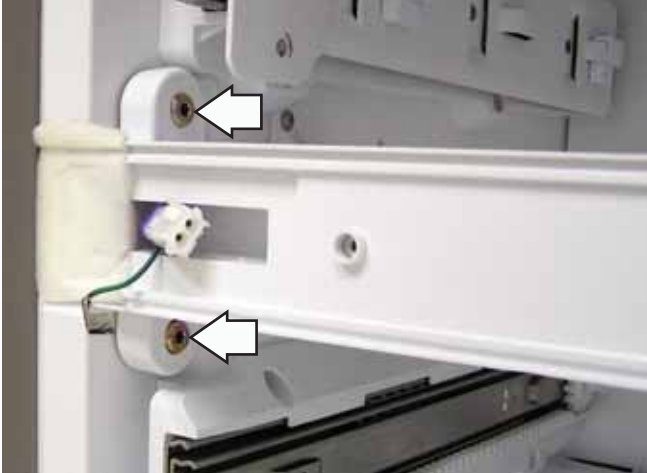

- Pull out the mullion from the recesses (1 on each side) in the freezer walls.
- Disconnect the mullion wire harness.

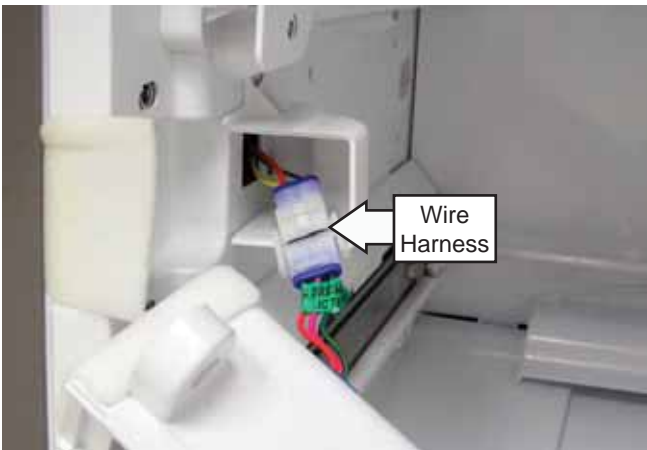

**Note:** To test the operation of the mullion heater, disconnect the humidity sensor. Within the next 20 minutes (duty cycle), the control will recognize the open humidity sensor, the heater will then receive voltage, and the mullion will get warm.

### Fresh Food/Freezer Mullion Heater

The fresh food/freezer mullion heater is foamed in place and is located behind the cabinet flange and between the freezer and fresh food compartments.

**Note:** If the Energy Saver light (if available) is on, then the fresh food/freezer mullion heater is disabled.

The heater is not replaceable.

### EMI Filter

The EMI Filter is accessed from the back of the refrigerator and is located on the left side of the compressor.

To remove the EMI filter:

- Remove the 5/16-in. hex-head screw that attaches the bracket to the cabinet.
- Pull the bracket out and remove the 1/2-in. nut.

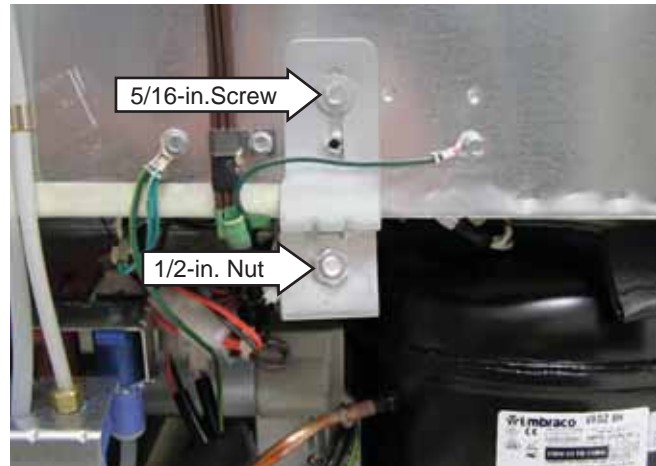

- Cut the 2 plastic wire ties that hold the EMI filter to the bracket.
- Mark and disconnect the wires from the EMI filter.

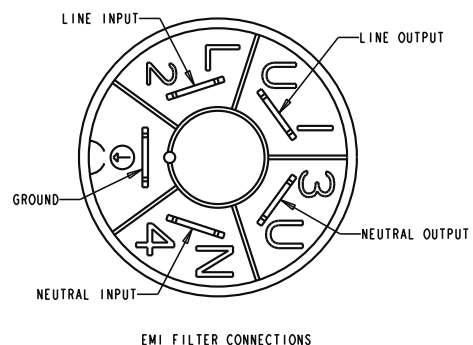
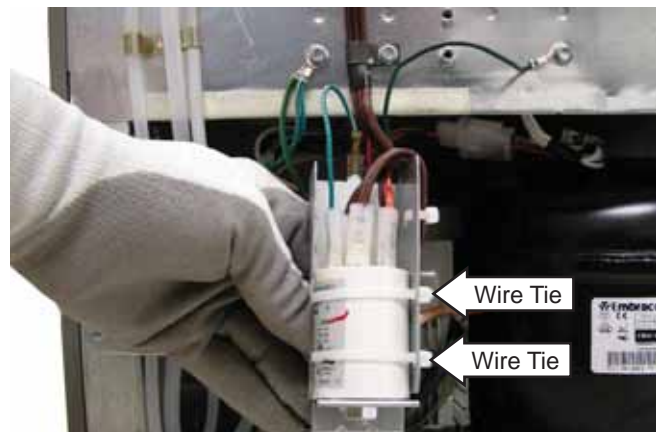

## Water Valve

The water valve is accessed from the back of the refrigerator and is located on the left side of the compressor. The valve contains 2 solenoids. The icemaker solenoid (red) has an approximate resistance value of 180  $\Omega$  and can be checked on the main control board J18 to J7-9. The water dispenser solenoid (blue) has an approximate resistance value of 320  $\Omega$  can be checked from J7-3 to J7-9.

To remove the water valve:

1. Shut off the water supply to the unit.
2. Remove the 1/4-in. hex-head screw that attaches the water valve bracket to the cabinet.
3. Lift and unhook the valve from the cabinet.

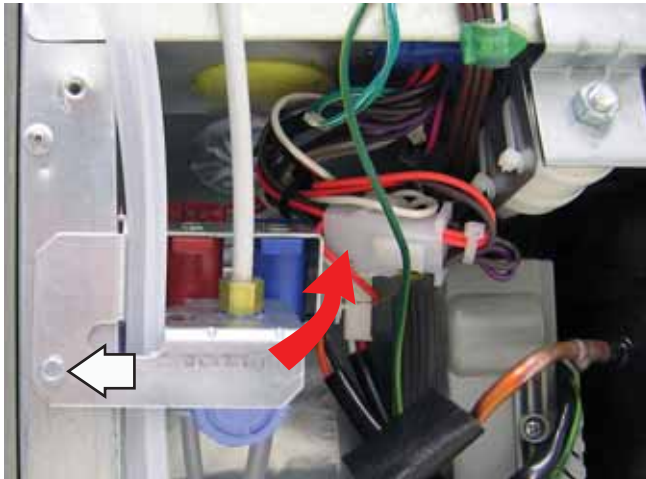

**Note:** In the following steps, some water may drain from the disconnected tubing. Use care to avoid water spills.

4. Remove the 1/2-in. nut and the water inlet tube.

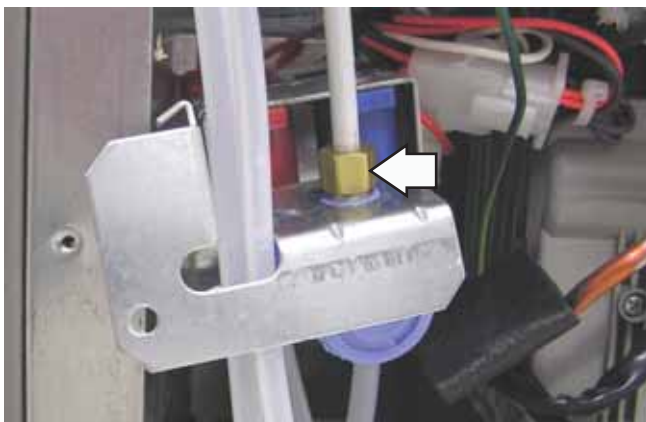

5. Disconnect both wiring harnesses from the valve.

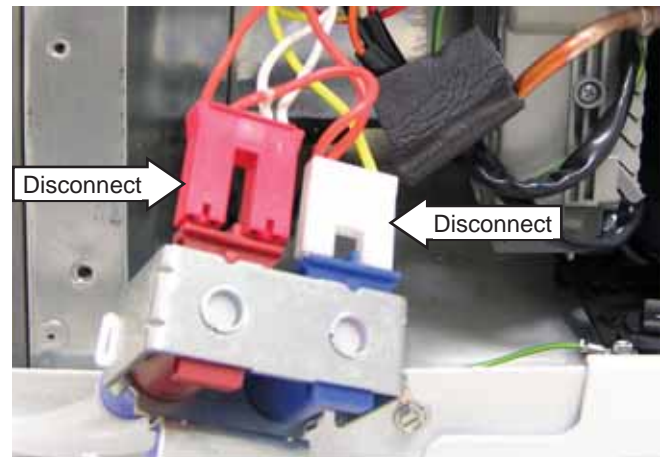

6. Press the John Guest connector collar and remove each outlet tube from the water valve.

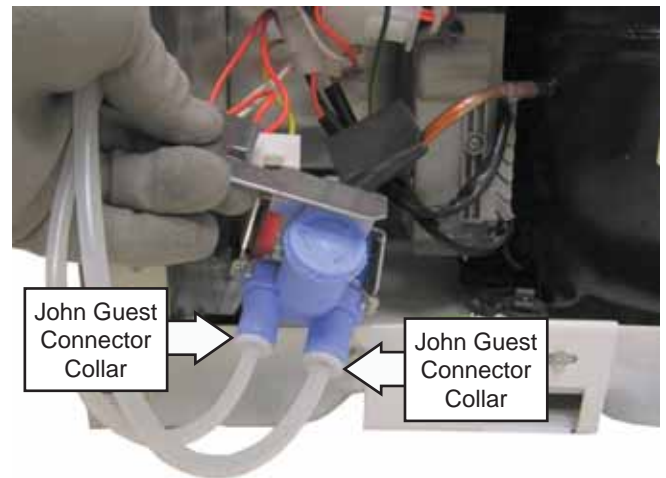

## Condenser Fan

The fan is mounted in the machine compartment with the no-clean condenser. The fan and fan shroud are mounted on one end of the condenser, and the other end of the condenser is blocked.

When the fan is operating, air is pulled from the center of the condenser, drawing air in through the coils. The air is then exhausted over the compressor and out the right side of the refrigerator.

Inlet air is available through the left front and left rear of the machine compartment. A rubber divider strip underneath the refrigerator divides the inlet and outlet sides of the machine compartment.

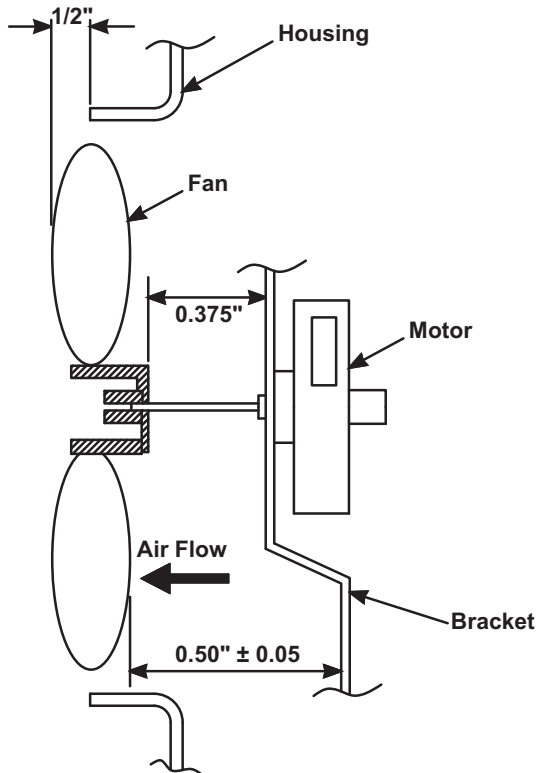
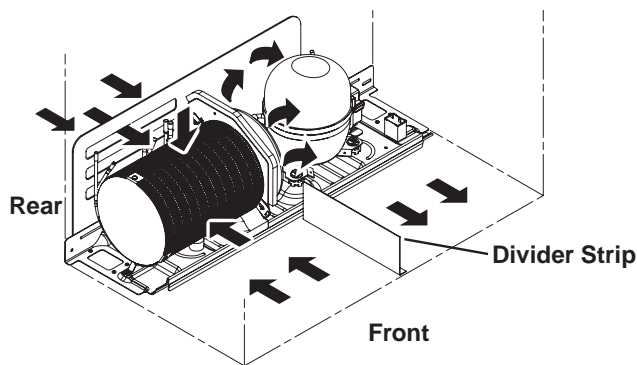

The rear access cover must be tightly fitted to prevent air from being exhausted directly out of the rear of the machine compartment, bypassing the compressor.

The condenser fan is mounted with screws to a fan shroud and mounting bracket that is attached to the condenser. To access the condenser fan motor, disconnect power from the refrigerator and remove the machine compartment cover.

Use one of the two following methods to remove the condenser fan motor from the refrigerator:

### Method #1

1. Disconnect the condenser fan harness, and then remove the 1/4-in. hex-head screw from the upper corner (closest to you).
2. Pull the shroud assembly slightly to disengage from the mounting tab.

**Note:** In the following step, adequate clearance may not exist to easily pull the assembly out. It may be necessary to reverse steps 1 and 2, and then proceed to method #2.

3. Tilt the shroud assembly towards the compressor and gently pull the assembly out.

### Method #2

1. Pull the condenser fan blade off the motor shaft.
2. Remove the two 1/4-in. hex-head screws that hold the mounting bracket together.
3. Remove the front mounting bracket and note the position of the grommet.
4. Disconnect the condenser fan harness, remove the wire harness from the fan shroud clips, and then remove the fan motor.

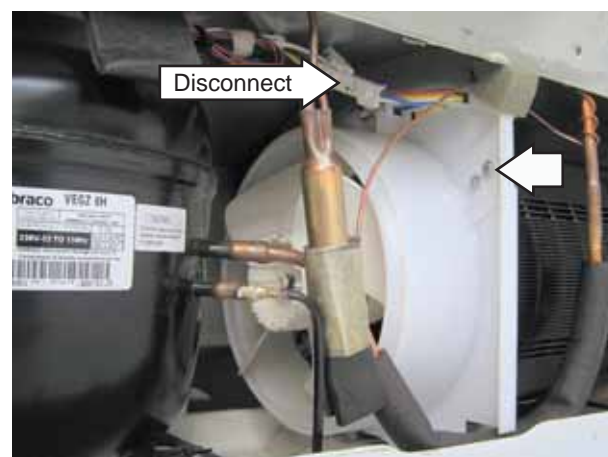

Condenser fan speed corresponds with compressor speed (low, medium, high) to minimize pressure variations in the sealed system except when the freezer temperature is 20°F above the set point. If this condition exists (such as during initial startup), the condenser fan operates at super high speed while the compressor operates at medium speed.

*(Continued next page)*

Supply voltage from the main control board (J2-8 to J2-3) remains at a constant 13.6 VDC.

The speed of the fan is controlled by the signal voltage output from the main control board (J2-5 to J2-3). Voltage output from the control board to the fan is 13.6 VDC; however, to regulate the speed of the fan, the main control board uses pulse width modulation (PWM).

When operating, voltage is sent in pulses (much like a duty cycle) as opposed to an uninterrupted flow. This pulsing of 13.6 VDC produces effective voltage being received at the motor, that is equivalent to a reduction in voltage.

Fan speed is selected and maintained by the main control board regulating the length and frequency of the 13.6 VDC pulse.

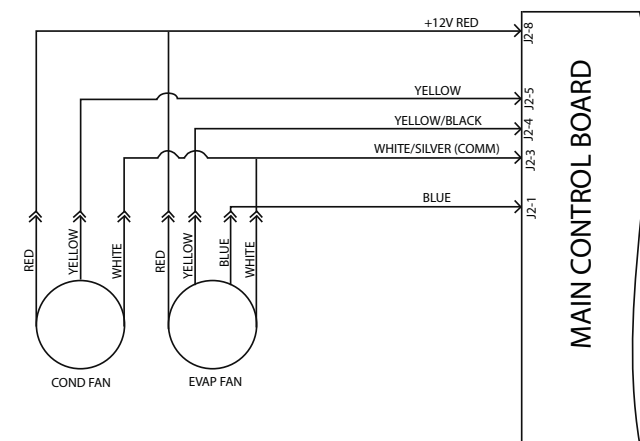

Temperature can cause some fan speed variation. Fan speed can vary +/- 5%, depending on the temperature, with higher temperatures causing slightly higher speeds.

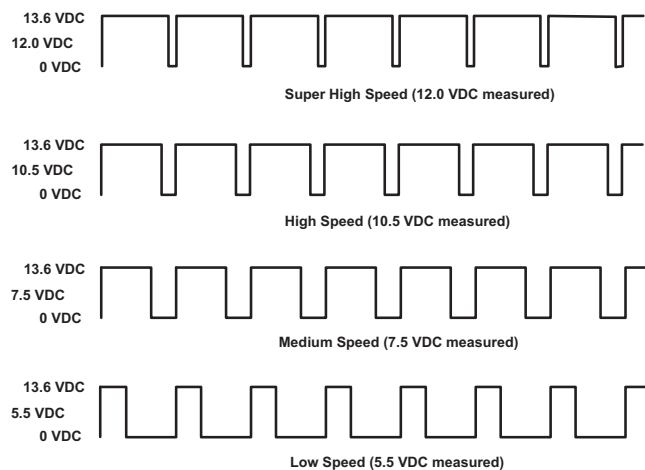

Voltage can be checked on the fan harness:

- Supply voltage (red and white wires) = 13.6 VDC
- Signal voltage (yellow and white wires) = 5.5 - 12 VDC, depending on speed of fan.

## Inverter

The inverter is accessed from the back of the refrigerator and is located on the left side of the compressor behind the water valve. The water valve must be removed to access the inverter.

To remove the inverter:

1. Remove the 1/4-in. hex-head screw that holds the water valve to the cabinet.

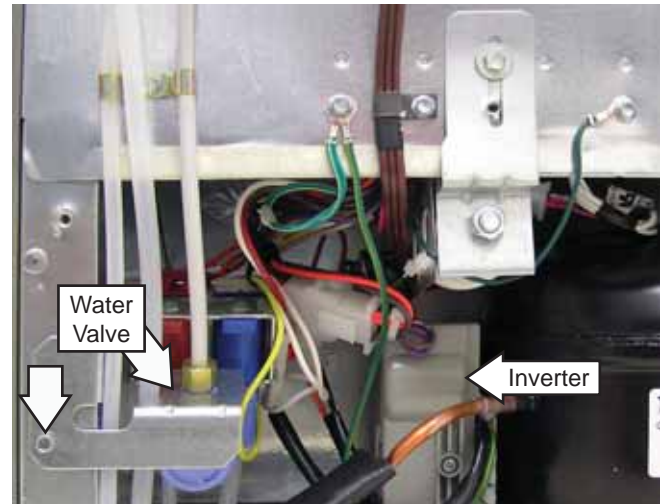

2. Carefully pull the water valve out from the cabinet.
3. Disconnect the 2 wire harnesses to the inverter.
4. Remove the 1/4-in. hex-head screw and the inverter ground wire from the cabinet.

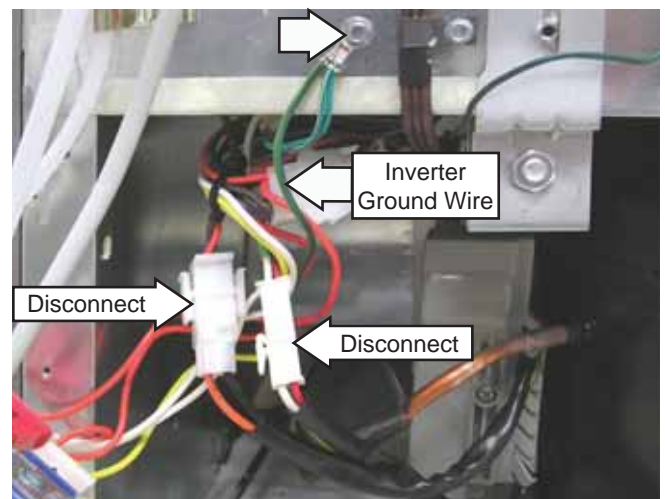

**Note:** The inverter is attached to the compressor by a lip above the compressor terminals, a tab (located at the bottom rear corner), and a Phillips-head screw.

*(Continued next page)*

5. Remove the Phillips-head screw from the inverter.



6. Lift and rotate the inverter counterclockwise.
7. Disconnect the compressor harness from the compressor terminals.

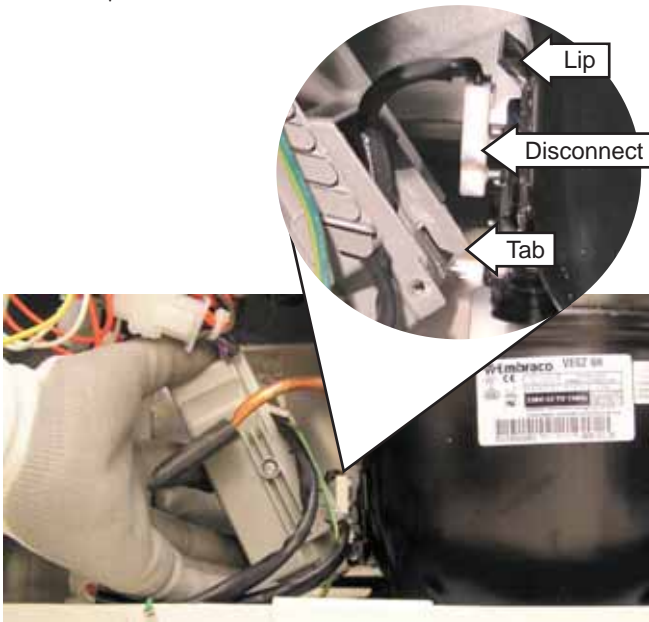

**WARNING:** When the refrigerator is plugged in, 120 VAC is always present at the inverter.

**Note:** Certain voltmeters will not be able to read voltage output from the inverter. If no voltage or erratic voltage is measured, it does not necessarily indicate a faulty inverter.

The inverter receives 120 VAC line-in from the power supply. The inverter converts this single-phase, 60 Hz, 120 VAC into 3-phase, 240 VAC, with frequency variations between 57 Hz and 104 Hz. This voltage is delivered to the compressor through 3 lead wires. Each wire will carry identical voltage and frequency.

**Note:** The compressor leads must be connected to measure voltage output. If the compressor wires are not connected, or if an open occurs in 1 of the 3 lead wires or in the compressor, the inverter will stop voltage output.

When checking inverter voltage output, connect the test-meter leads to any 2 of the 3 compressor lead wires at the inverter plug (plug should be connected). The same reading should be measured between any 2 of the 3 wires.

The inverter controls compressor speed by frequency variation and by Pulse Width Modulation (PWM). Changing frequency and PWM will cause an effective voltage between 80 and 240 VAC to be received at the compressor.

- Low speed (1710 rpm) - 57 Hz
- Medium speed (2100 rpm) - 70 Hz
- High speed (3120 rpm) - 104 Hz

The inverter receives commands from the main control board. The main control board will send a PWM run signal from the J15 connector of 4-6 VDC effective voltage to the inverter (all wires must be connected). The inverter will select compressor speed (voltage output) based on this signal.

The main control board will only send a run signal to the inverter when the compressor should be on.

**Note:** When measuring signal voltage (from the main control board) at the inverter, a reading of 4-6 VDC will be measured with all wires connected. If the inverter wiring is disconnected, the board output will measure between 10-12 VDC.

The inverter will monitor compressor operation. If the compressor fails to start or excessive current draw (4 amps maximum) is detected, the inverter will briefly stop voltage output. The inverter will then make 12 consecutive compressor start attempts (once every 12 seconds). If the compressor has not started after 12 attempts, an 8-minute count will initiate. After the 8-minute count, the inverter will attempt to start the compressor again. If the compressor starts, normal operation will resume. If the compressor fails to start, this process will be repeated. Removing power to the unit will reset the inverter count. When power is restored, the inverter will attempt to start the compressor within 8 minutes.

The inverter has a built-in circuit protection to guard against damage from a failed or shorted compressor. However, if a failed compressor is diagnosed, order a new compressor and inverter. If the compressor fails to start after replacement, replace the inverter.

## Inverter Compressor

**Caution:** Do not attempt to direct-start the compressor. The compressor operates on a 3-phase power supply. Applying 120 VAC to the compressor will permanently damage the unit. It is not possible to start the compressor without an inverter.

The compressor is a reciprocating, variable-speed, 4-pole type. It operates on 3-phase, 80 to 240 VAC within a range of 57 to 104 Hz.

**Note:** Certain voltmeters will not be able to read voltage output or frequency from the inverter.

Compressor wattages at various speeds are:

- LOW - 65 watts
- MED - 100 watts
- HIGH - 150 watts

The compressor is controlled by the inverter, which receives its signal from the main control board. Varying the frequency to the inverter changes the compressor speed.

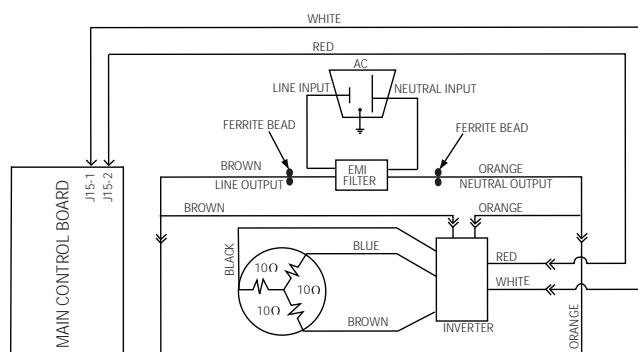

Compressor speed is based on the temperature set point in conjunction with the specific cabinet temperature. Speeds are selected according to the following cabinet temperatures, with freezer temperature being the primary:

- 7°F to 19.5°F above freezer set point = high speed.
- 4.5°F to 6.5°F above freezer set point = medium speed.
- 1°F to 4°F above freezer set point = low speed.
- 1°F to 2.5°F above refrigerator set point = low speed.

- 3°F to 5°F above refrigerator set point - medium speed.
- 5.5°F to 7°F above refrigerator set point - high speed.

**Note:** The compressor will run at medium speed if the freezer temperature is 20°F or more above the setpoint.

The use of 3-phase power eliminates the need for the relay, capacitor, and individual start and run windings; therefore, the start, run, and common pins found on conventional compressors are not applicable on this 3-phase model. Compressor pin functions are identical and compressor lead wire configuration is of no importance. A resistance of 9 Ω to 11 Ω should be read between any 2 of the 3 pins. Should an opening occur in the compressor winding or should one of the compressor lead wires become open or disconnected, the inverter will stop voltage output to the compressor.

Compressor operation is extremely smooth and cool. The compressor exterior may be slightly higher than room temperature while operating; therefore, it may be difficult to detect a running unit.

**To verify that the compressor is running:**

Disconnect power from the unit and place a hand on the compressor. Reconnect power and feel for a vibration when the compressor tries to start. It may take up to 8 seconds before the compressor attempts to start.

**Note:**

- When ordering a replacement compressor, order both the compressor and inverter. Replace the compressor first. If the compressor fails to start after compressor installation, replace the inverter.
- When servicing the compressor, it is important to dress the wiring to keep low voltage DC wiring and 120 VAC wiring separate.

# Troubleshooting

## Control Diagnostics Using Temperature Display

The temperature display has a self-diagnosis mode\* that can be accessed and will help the technician to test certain functions of the temperature display, defrost heater, damper, and interior fans. This mode can aid the service technician in quickly identifying failed or improper operation of certain components and systems.

Control diagnostics using the display does not use error codes to identify problems. Instead, the temperature display allows access to components or systems to be checked if a problem is detected.

The temperature display must be in an active mode before entering the self-diagnosis test. If the display is blank, press any temperature button once, then release it. The display will show actual temperatures.

Enter the diagnostic mode by pressing both the freezer temperature (*COLDER* and *WARMER*) pads and the refrigerator temperature (*COLDER* and *WARMER*) pads simultaneously. All 4 pads must be held for approximately 3 seconds. Blinking "00"s in both the freezer and refrigerator sections of the display indicate the refrigerator has entered the test mode. Remove fingers within 5 seconds and press any pad to lock-in the test mode. The blinking "00"s will change over to solid (non-blinking) "0"s when the test mode is locked-in. Failure to lock-in the test mode within 30 seconds will time out the test and return the refrigerator to the normal cooling mode.

\* Not all test modes apply to all models.

FZ Display	FF Display	Mode	Comments
0	1	Showroom Mode	When activated, a tone will sound briefly and the display will flash 1 time. The cooling system stops operation. All HMI functions will operate normally.
0	2	Display Combined HMI Software Version	Temperature to main controls communications test. A coded software version is displayed. Dispenser model will show 2 numbers. <b>See Note 1.</b> Internal display model will test for Pass/Fail. Should show "P". If the format is violated, the display will read "99".
0	3	Display Main Control Software Version	Temperature to dispenser communications test. A coded software version is displayed. Dispenser model will show 2 numbers. <b>See Note 1.</b> Internal display model will show "F" (no dispenser board). If the format is violated, the display will read "99".
0	4	Combined HMI to Main communications	Dispenser to main controls communications test. Dispenser model will test for Pass/Fail. Should show "P". Internal display will show "F" (no dispenser board).
0	6	HMI Self Test	Illuminates all LEDs and numerical segments. FF and FZ displays will initially display "88". Pressing temperature pads will change initial display. Remaining pads pressed will toggle the LED associated with that pad. Filter pad repeatedly pressed will toggle red, green, and amber LEDs. To exit HMI Self Test, press and hold both FF temperature pads simultaneously for 3 seconds, then release. (Exits test mode)
0	7	Sensor Self Test	Checks each thermistor in order and displays "P" for pass, "O" for open circuit, or "S" for shorted circuit. <b>See Note 2.</b>

(Continued next page)

FZ Display	FF Display	Mode	Comments
1	0	Open Damper	Damper will open, pause briefly, and then close.
1	1	Fan Speed Test	Cycles through each fan for 5 seconds.
1	2	100% Run Time	This mode runs the sealed system 100% of the time. This test will automatically time out after 1 hour of run time. A refrigerator reset may exit this mode.
1	3	Enter Pre-chill	This places the freezer in pre-chill mode essentially issuing a "Force Prechill" command to the main control. It will return to normal operation on its own. This command will be ignored if the refrigerator is set to OFF/ Standby mode.
1	4	Toggle the State of Defrost	Each time any button on the temperature board other than 4 temperature adjust buttons is pressed, the status of the FZ defrost heater will toggle. <b>See Note 3.</b>
1	5	Refrigerator Reset	Causes a soft reset to occur at both the Combined HMI and the Main board.
1	6	Test Mode Exit	Causes a soft reset to occur at the Combined HMI board. Note: This will not terminate test modes that the main board is maintaining as a result of the service diagnostics mode. To terminate test modes, Refrigerator Reset should be used.
1	7	Degree C/F	Used to set the temperature unit of measure. The current mode is displayed on the FF display ("C" or "F"). Use either of the FF slew keys to adjust the mode. Press any key other than the FF slew keys to set the unit of measure to the displayed selection.

**Note 1:** The first 2 digits are numbers. The second 2 digits are numbers that correspond to a letter (01=a, 02=b, 03=c,...26=z). For example, 61 and 9= a software version of 61i. 41 and 10=a software version of 41j.

**Note 2:** Display order: #1 = Fresh Food Thermistor, #2 = Ambient Thermistor, #3 = Freezer Thermistor, #4 = Evaporator Thermistor. #5 displayed = No Thermistor installed at this location.

**Note 3:** The heater will not come on if the evaporator thermistor is above 70°F.

## Main Control Board

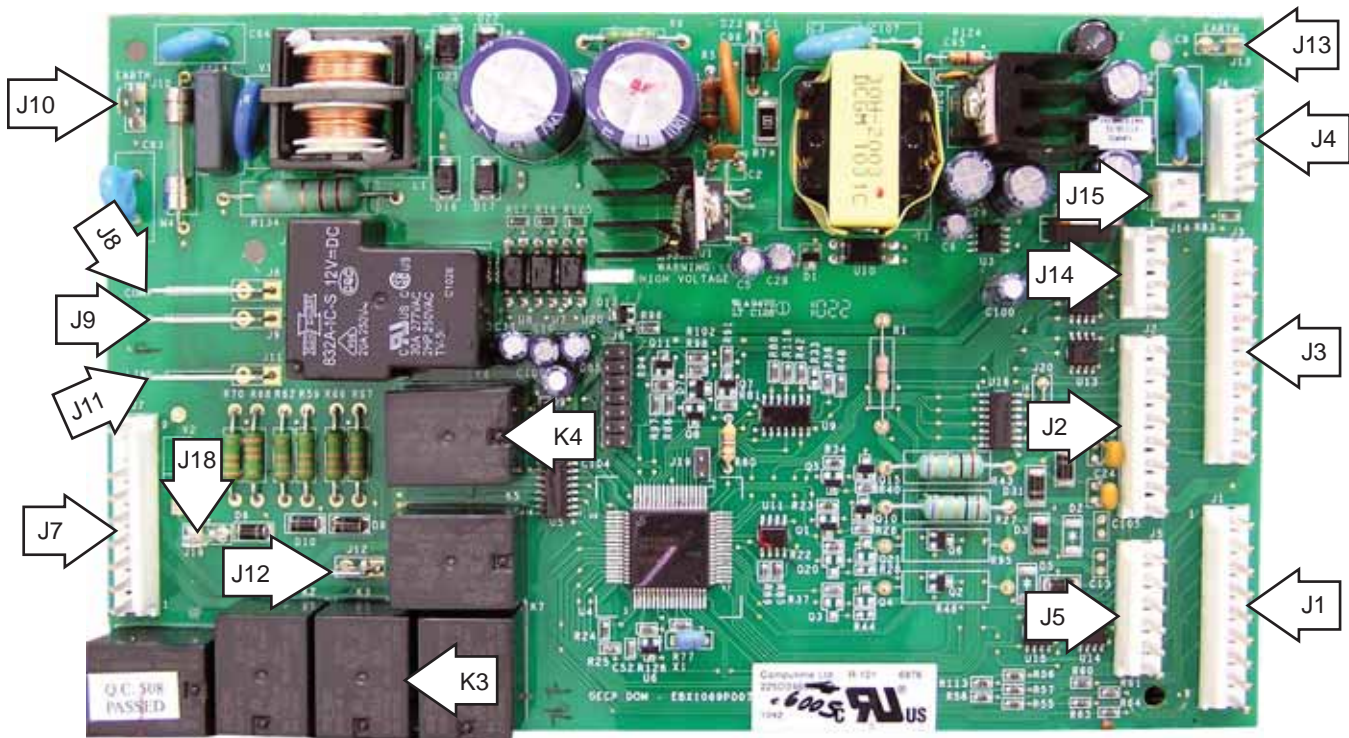

J10 and J13 - Earth (Ground)

J8 - Air Duct Heater, Supply Duct Heater

J9 - Defrost Heater, Over-temperature Thermostat, Return Duct Heaters,

J11 - Line (L1)

J7 - Auger Motor, Dispenser Water Valve, Duct Port Heater, Freezer Interlock Switches, Top Drawer and Bottom Drawer Light Switches

J12 - Double Door Mullion Heater, Fresh Food/Freezer Mullion Heater

J18 - Icemaker Water Valve (Automatic Quick Ice)

K3 - Water

K4 - Defrost

J15 - Inverter

J14 - Freezer and Fresh Food LED Lighting

J2 - Fan Common, Evaporator Fan, Condenser Fan, Air Duct Blower, Mullion Bar Heater,

J5 - Humidity Sensor, LED Lighting

J4 - Display Board

J3 - Damper

J1 - Fresh Food Thermistor, Ambient Thermistor, Freezer Thermistor, Evaporator Thermistor, Model Selector

## Heater Troubleshooting

AC Heaters	Resistance
Air Duct Heater ***	578 $\Omega$
Defrost Heater * (See <i>Defrost Heater</i> .)	31 $\Omega$
Double Drawer Mullion Heater * (See <i>Double Drawer Mullion Assembly</i> .)	827 $\Omega$
Duct Port Heater ***	1200 $\Omega$
Freezer/Fresh Food Mullion Heater *** (See <i>Fresh Food/Freezer Mullion Heater</i> .)	1653 $\Omega$
Return Duct Heater LH *** (See <i>Return Duct Heaters</i> .)	440 $\Omega$
Return Duct Heater RH *** (See <i>Return Duct Heaters</i> .)	440 $\Omega$
Supply Duct Heater ***	1653 $\Omega$

DC Heaters	Resistance (Approximate)
Door Gasket Heater **	62 $\Omega$
Duct Door Heater * (See <i>Dispenser and Interface</i> .)	109 $\Omega$
Fill Tube Heater **	300 $\Omega$
French Door Vertical Mullion Heater * (See <i>Articulating Door Mullion</i> .)	24 $\Omega$
Recess Heater **	145 $\Omega$

\* Replaceable individual heater

\*\* Replaced as door assembly

\*\*\* Not replaceable

### Note:

- Air Duct and Supply Duct heaters will come on with abnormally high door open time and high humidity. (Abnormal = approximately 70 fresh food door openings for 12 seconds or more in a 16 hour period.)
- Duct Door heater, Door Gasket heater, and Recess heater are on 100% of the time when the freezer set temperature is 4°F or lower. Above 4°F heater on-time will vary.
- Duct Port heater is located around ice compartment port holes, and cycles on temperatures and ice compartment conditions. (Mid-settings = heater on time approximately 30%)
- Fill Tube heater will be on after water valve activation or when ice is dispensed.

## Icemaker Service Test Mode

The electronic icemaker has a service test mode that can be utilized by the service technician in order to test basic operation of the icemaker. The service test mode consists of a harvest cycle followed immediately by a water fill. The harvest cycle is entered, regardless of icemaker temperature or arm position.

To enter the service test mode:

1. Turn the power switch to the **OFF** position and wait 20 seconds. (The green power light will be unlit.)
2. Turn the power switch to the **ON** position. (The green power light will be lit.)
3. Push the feeler arm from the out position to the in position and back again 3 times and only 3 times within 20 seconds.

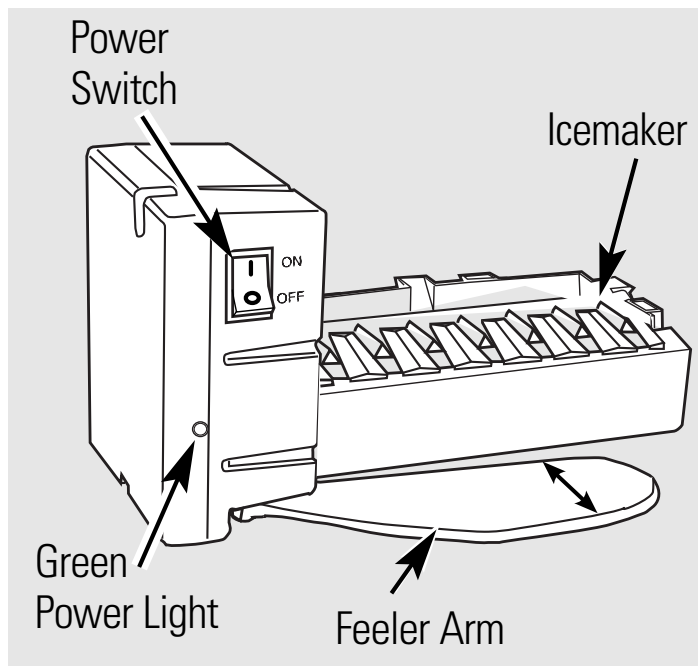

**Note:** If the icemaker has already started a harvest cycle and the arm is moving, it may be impossible to properly move the arm and enter the service mode without allowing it to reset and powering up again. If the icemaker is allowed to go through its normal harvest cycle, it will take 10-15 minutes after it dumps the ice for water to enter the icemaker.

While in the harvest mode, the heater will remain on for a minimum of 20 seconds. The water fill cycle will initiate the first fill (5.1 seconds) without waiting for the mold to prechill. Only one water fill occurs during the service mode. The icemaker will exit the service test on its own and enter the normal freeze cycle.



# Warranty



All warranty service provided by our Factory Service Centers or an authorized Customer Care® technician. To schedule service, on-line, visit us at [GEAppliances.com](http://GEAppliances.com), or call 800.GE.CARES (800.432.2737). Please have serial number and model number available when calling for service.

Staple your receipt here. Proof of the original purchase date is needed to obtain service under the warranty.

## For The Period Of: GE Will Replace:

### GE and GE PROFILE MODELS:

<b>One Year</b> From the date of the original purchase	<b>Any part</b> of the refrigerator which fails due to a defect in materials or workmanship. During this <b>limited one-year warranty</b> , GE will also provide, <b>free of charge</b> , all labor and related service to replace the defective part.
<b>Thirty Days</b> (Water filter, if included) From the original purchase date of the refrigerator	<b>Any part</b> of the water filter cartridge which fails due to a defect in materials or workmanship. During this <b>limited thirty-day warranty</b> , GE will also provide, <b>free of charge</b> , a replacement water filter cartridge.

### GE PROFILE MODELS ONLY:

<b>Five Years</b> (GE Profile models only) From the date of the original purchase	<b>Any part of the sealed refrigerating system</b> (the compressor, condenser, evaporator and all connecting tubing) which fails due to a defect in materials or workmanship. During this <b>limited five-year sealed refrigerating system warranty</b> , GE will also provide, <b>free of charge</b> , all labor and related service to replace the defective part in the sealed refrigerating system.
---	---

## What GE Will Not Cover:

- Service trips to your home to teach you how to use the product.
- Improper installation, delivery or maintenance.
- Failure of the product if it is abused, misused, or used for other than the intended purpose or used commercially.
- Loss of food due to spoilage.
- Replacement of house fuses or resetting of circuit breakers.
- Damage caused after delivery.
- Replacement of the water filter cartridge, if included, due to water pressure that is outside the specified operating range or due to excessive sediment in the water supply.
- Replacement of the light bulbs, if included, or water filter cartridge, if included, other than as noted above.
- Damage to the product caused by accident, fire, floods or acts of God.
- Incidental or consequential damage caused by possible defects with this appliance.
- Product not accessible to provide required service.
- Damage caused by a non-GE brand water filter.

**EXCLUSION OF IMPLIED WARRANTIES—Your sole and exclusive remedy is product repair as provided in this Limited Warranty. Any implied warranties, including the implied warranties of merchantability or fitness for a particular purpose, are limited to one year or the shortest period allowed by law.**

This warranty is extended to the original purchaser and any succeeding owner for products purchased for home use within the USA. If the product is located in an area where service by a GE Authorized Servicer is not available, you may be responsible for a trip charge or you may be required to bring the product to an Authorized GE Service location for service. In Alaska, the warranty excludes the cost of shipping or service calls to your home.

Some states do not allow the exclusion or limitation of incidental or consequential damages. This warranty gives you specific legal rights, and you may also have other rights which vary from state to state. To know what your legal rights are, consult your local or state consumer affairs office or your state's Attorney General.

Warrantor: General Electric Company, Louisville, KY 40225